



C A T A L O G U E 2 0 2 4

EYONA GAS EQUIPMENT CC



C O M P L E T E E Q U I P M E N T G U I D E

EST. 2004
20TH
ANNIVERSARY

WWW.EYONAGAS.ZA



TABLE OF CONTENTS

04. ABOUT EYONA GAS

07. DISTRIBUTORS FOR

12. ALGAS-SDI VAPOURISERS

19. LPG PUMPS

23. FISHER REGULATORS

29. MARSHALL-EXCELSIOR REGULATORS

31. GNALI + METRIX REGULATORS

33. MARSHAL & COPRIM TANK EQUIPMENT

4. FISHER INTERNAL VALVES

52. GAS METERS

66. LPG MANIFOLDS

THIS CATALOG IS DESIGNED TO PROVIDE A COMPREHENSIVE OVERVIEW OF EYONA GAS'S PRODUCTS. DUE TO THE CONTINUOUS DEVELOPMENT AND ADDITIONS TO OUR PRODUCT LINES, THIS CATALOG MAY NOT INCLUDE ALL THE PRODUCTS WE OFFER.

WE ALSO COULD NOT INCLUDE ALL THE DIFFERENT OPTIONS FOR OUR ITEMS, PLEASE CONTACT US DIRECTLY FOR ADDITIONAL INFORMATION OR PRODUCT REQUESTS.



ABOUT EYONA GAS

Since 2004, Eyona Gas Equipment has been a family-run business, we have been distributing the best LPG equipment in the world to the Southern African Industrial Gas Market, specialising in Vapourisers, regulators, pumps, and valves.

At Eyona Gas, we pride ourselves on service and quality. We have offices in Cape Town and Johannesburg and regularly do countrywide trips to service Kwa-Zulu Natal, Eastern Cape, and Bloemfontein.

Eyona Gas Equipment has exclusive distributor rights to Algas-SDI, Marshall Excelsior, Fisher, Coprim and Metrix gas meters.

We always send a representative to the global trade shows to ensure that we remain abreast of developments in LPG and new products coming into the market.

Our mission is to supply our valued customers with the highest quality products in the world. To continually seek out innovative products, helping our customers exceed their client's business needs. We promise to give our customers the very best after-sales service to ensure their clients receive a seamless service.

PROUD DISTRIBUTORS FOR

We take pride in having long-standing relationships with the world leaders in LPG/NG equipment.

We are proud sole distributors for:



About Algas-SDI

Algas-SDI Mission

Our Business

Algas-SDI is a manufacturer of products and systems for the reliable deployment of clean fuels worldwide. We design and manufacture industry leading LP-Gas Vaporizers, industrial process heating burners, Synthetic Natural Gas (SNG) systems for replacing or augmenting the supply of Natural Gas, Natural Gas-air mixers for augmenting the supply of digester gas from renewable sources (RNG), CNG and RNG decompression and pipeline injection systems, Ammonia vaporizers for thermal de-NOx and industrial processes. Algas-SDI, together with its partners world-wide, offers its customers an excellent single source for design, installation, and service for total system needs, supported by expert application engineering services.

Our Vision

We will be a quality-driven company, treating our employees with respect, while expecting them to continually improve their knowledge and skills; we will continuously improve our processes, delegating decision-making to the most knowledgeable people; we will work to improve our communities, and create an enjoyable work environment; we will become the global, technical, and market leader in the industry while focusing on our primary products and customers; we will pursue safety in all our product designs; and we will be ethical corporate citizens.

Our Values

At Algas-SDI, we know that things work better when we work together toward a common goal. That's why we forge working partnerships with our employees, our suppliers, our communities, and most importantly, our customers. We work together with our partners under this same principle.... always working together to bring you the optimal solution to your most challenging opportunities.



Zimmer Vaporisers



E y o n a G a s E q u i p m e n t

w w w . e y o n a g a s . c o . z a

0 2 1 5 5 1 5 6 9 9 - 0 1 1 8 6 8 1 4 9 4



Zimmer™

Dry-Electric LPG Vaporizer



ZIMMER™ is the most hassle-free, easy-to-use vaporizer on the market. It offers a compact, affordable, energy-efficient design and requires virtually no maintenance. When quality, simplicity and reliability are your priorities, just choose **ZIMMER**.

KEY POINTS:

- ➔ Hands Down the Most Reliable and Trouble-Free Vaporizer Available
- ➔ 98% Thermal Efficiency
- ➔ Self-Modulating Heaters Use the Minimum Energy Required to Meet the Demand of the Load
- ➔ Easy Access to All Maintainable Components
- ➔ Dry-Electric Design — No Water, No Glycol to Maintain
- ➔ Aluminum Construction — Corrosion Free
- ➔ Easy to Install — Multiple Mounting Options
- ➔ Various Voltage Configurations Can be Applied to Factory Installed Explosion Proof Seal-Off
- ➔ Start-Up In Less Than 60 Seconds — LPG Vapor When You Need It



The technology behind the dry-electric **ZIMMER** is advanced, yet simple to operate. Algas-SDI innovated every element of the **ZIMMER** design ensuring years of safe, reliable, affordable, and easy-to-use LPG vaporization.

IDEALLY SUITED FOR:



START-UP: Less than 1 minute depending on ambient temperature

ZIMMER is protected under various granted and pending patents. For more information, visit www.algas-sdi.com/patents for more details.

ZIMMER VAPOURISER

DESCRIPTION	CODE	INLET & OUTLET	
Z25 Zimmer 25Kg/Hr 220V ZONE 1	180801	½ FNPT x ½” FNPT	Zimmer Brochure
Z40 Zimmer 40Kg/Hr 220V ZONE 1	160001	½ FNPT x ½” FNPT	Zimmer Brochure
Z50 Zimmer 50Kg/Hr 220V ZONE 1	180220	½ FNPT x ½” FNPT	Zimmer Brochure
Z100 Zimmer 100kg/HR 220V or 380V w/Neutral	160004	¾” FNPT x ¾” FNPT	Zimmer Brochure
Z150 Zimmer 100kg/HR 220V or 380V w/Neutral	160003	¾” FNPT x ¾” FNPT	Zimmer Brochure





TYPICAL ZIMMER

INSTALLATION



Liquid Manifold

Liquid manifold
usually from D5 to D10



Globe Valve

ME825-4 1/2" Globe
Code: 180058



Strainer

ME650 1/2" Strainer
Code: 180063



HP Reg

Fisher 64-35 130kg/hr
Code: 160034



Gauge

0-2500 & 0-250kpa
Code: 180192 & 180202



Filt-EZE

Containment separator
Code; 160002



CONTACT US

Cape Town:
ct@eyonagas.co.za
021 551 5699

www.eyonagas.co.za

Gauteng:
admin@eyonagas.co.za
011 868 1494

Torrexx Vapouriser

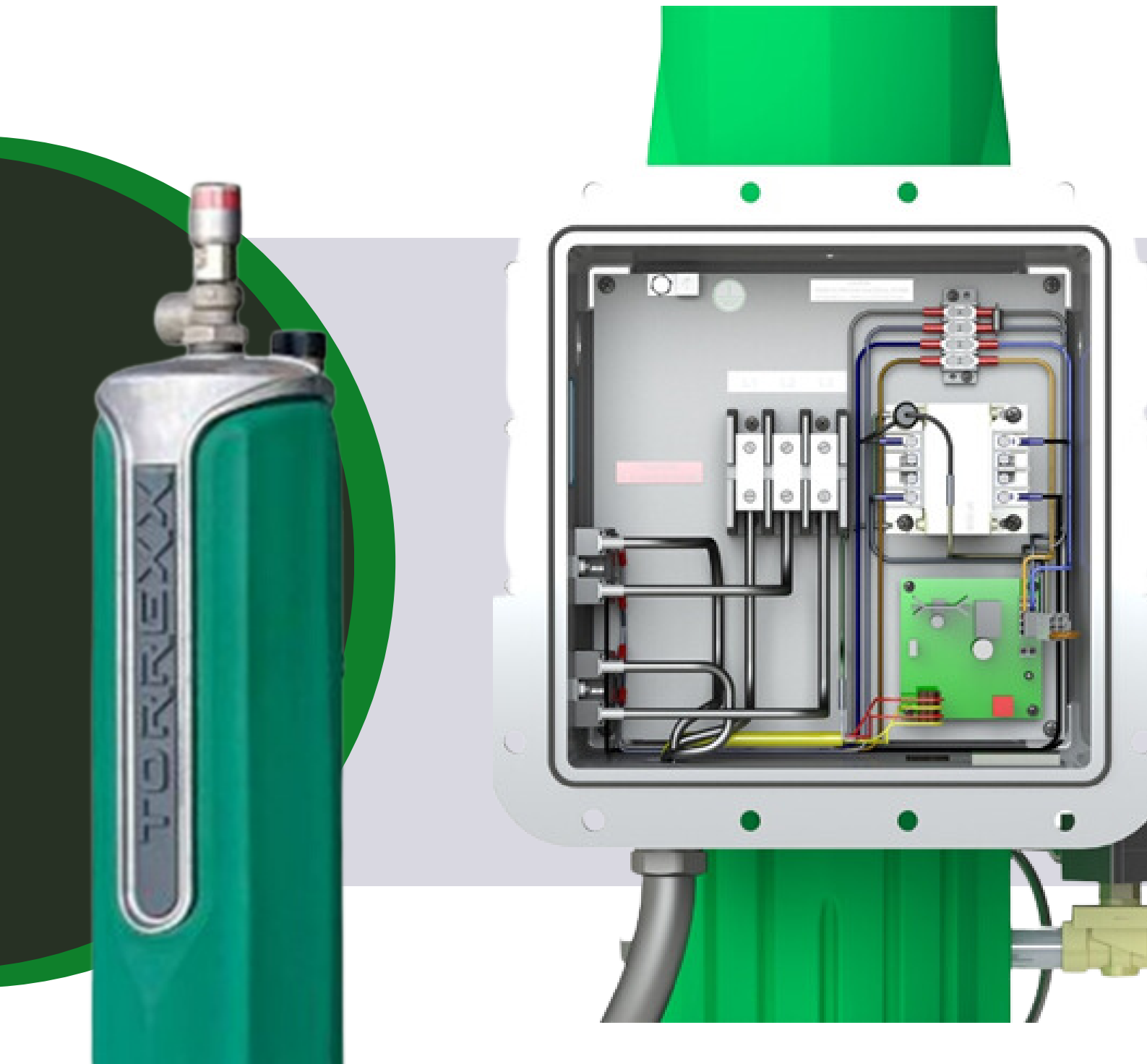

E y o n a G a s E q u i p m e n t

w w w . e y o n a g a s . c o . z a

0 2 1 5 5 1 5 6 9 9 - 0 1 1 8 6 8 1 4 9 4



Torrexx Vapourisers

Dry Electric LP-Gas Vaporizer Indirect Heated CE Marked
Torrexx is a heavy-duty, fast acting LP-Gas vaporizer which provides reliable and efficient process performance for commercial, municipal and industrial applications worldwide. Its aluminum construction and compact footprint make it light weight and easy to move and install!

KEY POINTS:

- **Solid-state relay for reduced maintenance** (*high-capacity models 240Kg/h-320Kg/h*)
- **Heavy-duty contactor** (*low-capacity models 25kg/h-160Kg/h*)
- 98% thermal efficiency
- Corrosion - Free
- Simple & Compact
- No water glycol
- Liqui-SAFE™ Valve
- Auto-restart after power interruption
- Easily fits inside cabinet



Since our first dry electric vaporizer patent in 1972, Algas-SDI has shipped tens of thousands of units to more than 90 countries on six continents.

Torrexx defines the industrial standard for dry electric LPG vaporizers. Heater control is through the use of a solid-state relay or robust contactor (depending on the model). In the event of a "high liquid level occurrence," our proprietary Liqui-Safe Valve™ prevents liquid LPG from passing downstream of the vaporizer. The valve provides visual indication of activation. This allows easy troubleshooting and assures the end-user the device is functioning properly.

Torrex Vapouriser

Description	Code	Inlet & Outlet	Brochure
TX 100 Dry Electric Vapouriser 100kg/Hr 380v ZONE 1	180038	¾" FNPT x 1" FNPT	<u>TX Brochure</u>
TORREXX TX 160 Dry Electric Vapouriser 100kg/Hr 380v ZONE 1	15999	¾" FNPT x 1" FNPT	<u>TX Brochure</u>
TORREX SSR TX 240 Dry Elec Vapouriser 240kg/Hr 380v ZONE 1	150005	¾" FNPT x 1" FNPT	<u>TX Brochure</u>
TORREX SSR TX 320 Dry Elec Vapouriser 320kg/Hr 380v ZONE 1	180029	¾" FNPT x 1" FNPT	<u>TX Brochure</u>

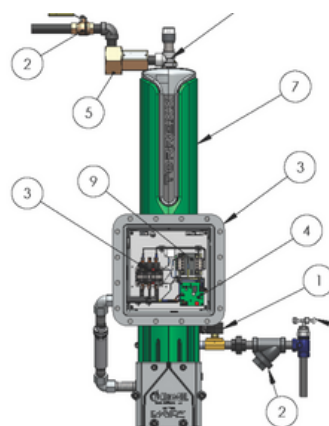

Hydrexx Vapouriser



E y o n a G a s E q u i p m e n t

w w w . e y o n a g a s . c o . z a

0 2 1 5 5 1 5 6 9 9 - 0 1 1 8 6 8 1 4 9 4



HYDREXX VAPOURISER

DESCRIPTION	CODE	INLET & OUTLET	Brochure
Vap Hydrexx HX500 Zone1 (500Kg/Hr) (Hot Water / Steam)	180388	3/4" FNPT x 1" FNPT	Hydrexx Brochure
Vap Hydrexx HX500R Zone2 (500Kg) c/w Hot Water System Skid 220v	180380	3/4" FNPT x 1" FNPT	Hydrexx Brochure



HX500 skid mounted on wheels
Code: 180380

Direct Fired Vapouriser



E y o n a G a s E q u i p m e n t

w w w . e y o n a g a s . c o . z a

0 2 1 5 5 1 5 6 9 9 - 0 1 1 8 6 8 1 4 9 4



DIRECT FIRED VAPOURISER

DESCRIPTION	CODE	INLET & OUTLET	BROCHURE
DF 40/40 80kg/hr with auto igniter	160005	¾" FNPT x 1" FNPT	_DF Brochure
DF 80/40 160kg/hr with auto igniter	160007	¾" FNPT x 1" FNPT	_DF Brochure
DF 120/60 240kg/hr with auto igniter	160008	¾" FNPT x 1" FNPT	_DF Brochure
DF 160H 320kg with auto igniter	159912	¾" FNPT x 1" FNPT	_DF Brochure
DF 320H 640kg with auto ignite	180392	2" FNPT x 2" FNPT	_DF Brochure
DF 480H 960kg/hr with auto igniter	159912	2" FNPT x 2" FNPT	_DF Brochure
DF 640H 1280kg/hr with auto igniter	160021	2" FNPT x 2" FNPT	_DF Brochure
DF 800H 1600kg/hr with auto igniter	1803921	2" FNPT x 2" FNPT	_DF Brochure



DF40/40 80kg/hr
Code: 160005

Aquavaire Waterbath Vertical Vapouriser



E y o n a G a s E q u i p m e n t

w w w . e y o n a g a s . c o . z a

0 2 1 5 5 1 5 6 9 9 - 0 1 1 8 6 8 1 4 9 4



AQUAVAIRE WATERBATH VERTICAL VAPOURISER

DESCRIPTION	CODE	BROCHURE
AQUAVAIRE Waterbath Q960V 1840kg/hr		Aquavaire
AQUAVAIRE Waterbath Q1120V 2150kg/hr		Aquavaire
AQUAVAIRE Waterbath Q1375V 2640kg/hr		Aquavaire
AQUAVAIRE Waterbath Q1650V 3332kg/hr	180866	Aquavaire



Aquavaire Waterbath Q1650
Code: 180866

Aquavaire Waterbath Horizontal Vapouriser



E y o n a G a s E q u i p m e n t

w w w . e y o n a g a s . c o . z a

0 2 1 5 5 1 5 6 9 9 - 0 1 1 8 6 8 1 4 9 4



AQUAVAIRE WATERBATH HORIZONTAL VAPOURISER

DESCRIPTION	CODE	BROCHURE
AQUAVAIRE Waterbath Q3300H 6330kg/hr	7777	Aquavaire Horizontal
AQUAVAIRE Waterbath Q4400H 8450kg/hr	7777	Aquavaire Horizontal
AQUAVAIRE Waterbath Q5500H 10550kg/hr	7777	Aquavaire Horizontal
AQUAVAIRE Waterbath Q7500H 14400kg/hr	7777	Aquavaire Horizontal
AQUAVAIRE Waterbath Q10000H 19200kg/hr	7777	Aquavaire Horizontal
AQUAVAIRE Waterbath Q12500H 24000kg/hr	7777	Aquavaire Horizontal
AQUAVAIRE Waterbath Q15000H 28800kg/hr	7777	Aquavaire Horizontal



Waterbath Q5500H 10550kg/hr
Code: 7777

LPG FILLING PUMPS

- ▶ We have a full range of LPG filling pumps , from small cyclinders Filling pumps up to large commercial/industrial filling pumps.

We offer these various units in skid mounted form with motor etc.
We can also tailor to our customers needs.

Get in touch with us

- Cadac Filling Pumps
- Above-ground Bulk Tank Pumps
- Underground Bulk Tank Pumps



About Hydro-Vacuum S.A.

Hydro-Vacuum S.A. is currently the most notable Polish manufacturer of pumps and pumping systems, and has been present on the market for over 150 years. The vast experience of Hydro-Vacuum S.A. in the pumping industry and its dynamic development has won the company the position of leading pump manufacturer. The basic activity of the company consists of the manufacture of pumps and pump systems, as well as foundry engineering.

Hydro-Vacuum S.A. means intellectual potential and high production capacity. The company can fully satisfy the demands of its clients with regard to pumps and pumping systems, especially concerning the plumbing industry. About 70 thousand pumps and other devices forming part of the pumping systems leave our production lines annually. Hydro-Vacuum S.A. has a 70+ percent market share in Poland for industrial deep-well pumps, and supplies 50% of all waste water pumping stations with separation of solid bodies. purchased by Polish clients. 90% of the LPG pumps operating within CIS countries also come from Hydro-Vacuum S.A.

Development of modern products fulfilling the complex needs of our clients, and the resulting improvements of our Research and Development Department, constitute priorities for Hydro-Vacuum S.A. Improving the efficiency of our pumps, pump assemblies and pumping systems, as well as a wider range of manufacturing facilities, are the primary objectives of the research and development works we undertake.

The R&D Department and technical assistance departments employ about 50 people, including individuals with professor and doctoral degrees in engineering. They have at their disposal the most up-to-date computer equipment as well as specialist software to support the design processes, such as SolidWorks, Numeca, ANSYS, Visual Nastran, and Fluent. The design engineers cooperate with scientific centres, including five technical universities. Many Hydro-Vacuum S.A. designs have obtained Polish and European patents. The innovative activity of Hydro-Vacuum S.A. has been listed in the leading positions in the ranking of Polish innovative companies by the Rzeczpospolita daily newspaper for several years.

Production at our current plant has been based for over 20 years on the integrated systems of quality, environmental and industrial safety management (ISO 9001, ISO 14001, and PN-N-18001).

Hydro-Vacuum S.A. exports its products to over 40 countries around the world, and they are appreciated not only by their users but also by experts in the pumping industry. Among the numerous prizes and awards granted to the company we should mention Złote Medale MTP Poznań (Gold Medals of MTP Poznań), Wyróżnienia Targów WOD-KAN Bydgoszcz (WOD-KAN Fair Bydgoszcz Award), and Medale Targów TIWS Kielce (Medals of TIWS Fair in Kielce).



w w w . e y o n a g a s . c o . z a

0 2 1 5 5 1 5 6 9 9 - 0 1 1 8 6 8 1 4 9 4

LPG FILLING PUMPS

L P G F I L L I N G P U M P S



E y o n a G a s E q u i p m e n t

w w w . e y o n a g a s . c o . z a

0 2 1 5 5 1 5 6 9 9 - 0 1 1 8 6 8 1 4 9 4





Viking Fill

Key Points

- 4.5 minutes to fill a 9kg
- 10gram scale increments
- Raised key-pad for ease of use
- User Friendly



www.eyonagas.co.za

Digital Scale

Viking Fill

Let's
Connect



Phone

021-551-5699

Website

www.eyonagas.co.za

Email

ct@eyonagas.co.za
jhb@eyonagas.co.za



Trade & Metrology Certified



Explolabs Certified

LPG FILLING MACHINE

VIKING FILL



An LPG Gas Filler to easily fill CADAC bottles, quietly and quickly.

FEATURES:



- Heavy duty industrial pump.
- Pump fills at 7LPM.
- Low noise when filling.
- Steel box, fully epoxy coated.
- Electrical Class: Zone 1 – 11B
- Outlet pressure gauge for monitoring fill pressures.
- Fills CADAC to 9kg cylinders.
- Liquid flow switch fitted to prevent pump running dry. Optional Extra.
- Auto cut-out when cylinder full.

Eyona Gas Equipment cc

Cape Town:

ct@eyonagas.co.za

021 551 5699

visit www.eyonagas.co.za

Gauteng:

admin@eyonagas.co.za

011 868 1494

Description	Code	Certified	Pump RPM	Filling time
Viking Filling Pump DIGITAL SCALE w/motor 220v C/W Digital Scale 10gr DIV	190100	Fill up to 19kg Bottles	44 Revolutions per minute 2 Strokes per revolution	+/- 30 Seconds per Kg (Dependant on factors)
Viking Filling Pump MECHANICAL SCALE w/motor 220v C/W Mechanical Scale 50gr DIV	180612	Fill up to 19kg Bottles	44 Revolutions per minute 2 Strokes per revolution	+/- 30 Seconds per Kg (Dependant on factors)
Viking Pump Hand Operated LPG Pump 1/2" In/Out C/W Scale	180414			



Viking Fill Mechanical Scale
Code: 180612



Viking Fill Digital Scale
Code: 190100

EYONA GAS EQUIPMENT CC

Industrial LPG Self-Priming Pumps



Pumps for underground
& above ground tanks



Skid mounted w/motor

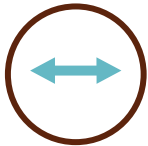

Multiple pump sizes



Industry respected
Self-priming ability



SKC Above Ground w/motor



SKD Underground w/motor



About FISHER

Fisher Control Valves

Reliability

Reliability With more than 125 years of experience, Emerson has built a solid reputation for reliability. Our regulators, valves and flow control systems are engineered to exacting standards, each carefully designed, thoroughly tested and developed to handle higher pressures while providing increased delivery capacity, reduced noise output and zero emission. We go beyond baseline industry standards to ensure our equipment operates reliably in even the most extreme conditions anywhere in the world. At Emerson, we are committed to continually raising the bar in our efforts to develop still higher quality, more advanced systems that operate safely and reliably well into the future.

Technology

Technology Emerson's innovative technologies creates pressure and flow control solutions more productive, efficient and costeffective. Our proven results are what make us the leader in the industry. Spanning the globe, our test and evaluation facilities provide the engineering expertise required to ensure superior quality product design and high performance results wherever our products are deployed. At these facilities, we test all sizes and types of regulators under real-world plant conditions to ensure production performance, efficiency, environmental compliance and safety before actual installation at your site. Our test and evaluation facilities are dedicated to tackling the toughest engineering challenges facing today's process manufacturing and energy industries, including helping companies deliver record volumes of natural gas and other forms of energy, consume less energy, reduce costs, operate more quietly and reduce greenhouse emissions.



FISHER REGULATORS



ZIMMER



E y o n a G a s E q u i p m e n t

w w w . e y o n a g a s . c o . z a

0 2 1 5 5 1 5 6 9 9 - 0 1 1 8 6 8 1 4 9 4



1ST STAGE / HIGH PRESSURE

DESCRIPTION	CODE	INLET & OUTLET	OUTLET PRESSURE
Fisher R112H-AAJ 24kg/hr	160072	1/4" FNPT x 1/2" FNPT	70kpa
Fisher R622H-BGJ 54kg/hr	160037	1/2" FNPT x 1/2" FNPT	35 - 70kpa
Fisher 64-35 Hp 130kg/hr	160032	1/2" FNPT x 1/2" FNPT	0.34 - 2bar
Fisher 627-7710 400kg/hr	160034	1" FNPT	0.34 - 1.4bar



Fisher 64/35
Code: 160032



Fisher 627-7710
Code: 160034

w w w . e y o n a g a s . c o . z a

0 2 1 5 5 1 5 6 9 9 - 0 1 1 8 6 8 1 4 9 4

INDUSTRIAL REGULATORS

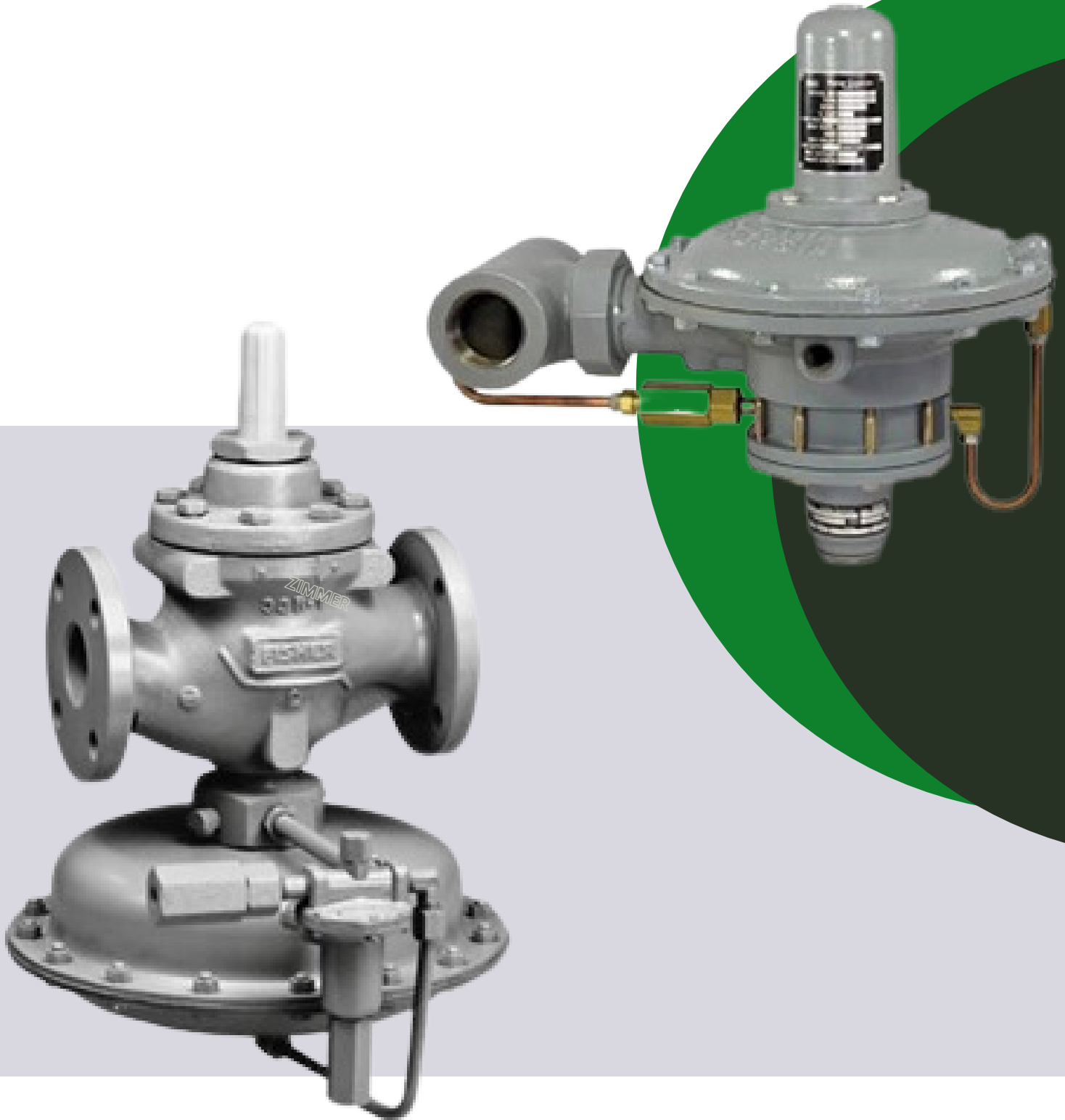

E y o n a G a s E q u i p m e n t

w w w . e y o n a g a s . c o . z a

0 2 1 5 5 1 5 6 9 9 - 0 1 1 8 6 8 1 4 9 4



COMMERCIAL/ INDUSTRIAL HIGH PRESSURE

DESCRIPTION	CODE	INLET & OUTLET	OUTLET PRESSURE
Fisher 630-104/78 1000kg/hr	180165	2" FNPT	0.55 – 1.4bar
Fisher 299H-104 800kg/hr	160056	2" FNPT	0.41 – 1.1bar
Fisher 99-901PH w/pilot 2000kg/hr	160030	2" FNPT	0.69 – 4.5bar
Fisher 99F-901PH w/pilot 2000kg/hr	180530	2" 300# Flanged	0.69 – 4.5bar
Fisher 1098-F43 20,000kg/hr	180075	4" 300# Flanged	2.4 – 5.2bar
Fisher 98H BACK PRESSURE Reg	160098	1" FNPT	



Fisher 630-104/78
Code: 180165



Fisher 98H
Code: 160098

TWIN STAGE (TANK PRESSURE TO 2.8KPA)

DESCRIPTION	CODE	INLET & OUTLET	OUTLET PRESSURE
Fisher R232A-BBF 10kg/hr	180807	1/4" FNPT x 1/2" FNPT	2.8kpa

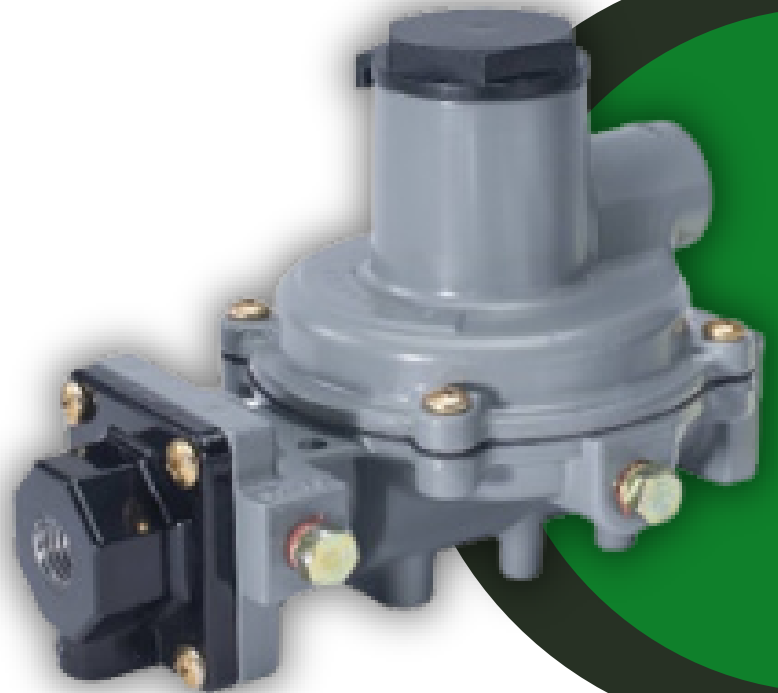

E y o n a G a s E q u i p m e n t

w w w . e y o n a g a s . c o . z a

0 2 1 5 5 1 5 6 9 9 - 0 1 1 8 6 8 1 4 9 4



2ND STAGE / LOW PRESSURE

DESCRIPTION	CODE	INLET & OUTLET	OUTLET PRESSURE
Fisher 222-BAF 10kg/hr	180078	1/2" FNPT	2.4 - 3.2kpa
Fisher R622-BCF 20kg/hr	160039	1/2" FNPT	2.4 - 3.2kpa
Fisher R622-DFF 30kg/hr	160040	3/4" FNPT	2.4 - 3.2kpa
Fisher HSRL-CFC 54kg/hr	180805	1" FNPT	2.2 - 3.2kpa



Fisher R622 BCF
Code: 160039



Fisher HSRL-CFC
Code: 180805

COMMERCIAL / INDUSTRIAL LOW PRESSURE

DESCRIPTION	CODE	INLET & OUTLET	OUTLET PRESSURE
Fisher 299H-102 400kg/hr		2" FNPT	2.2 – 5kpa
Fisher 133L-4 1420kg/hr		2" FNPT	2.1 -4.5kpa



Fisher 299H-102
Code:

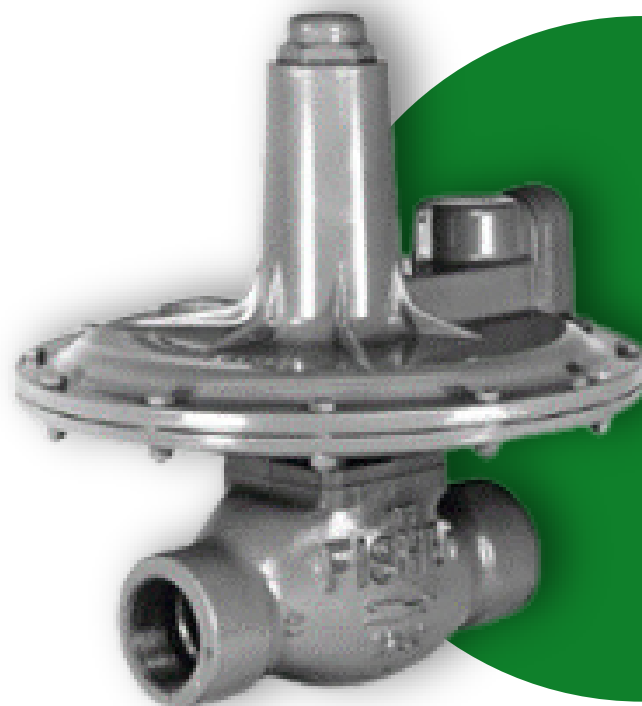

Fisher 133L-4
Code:

About Marshall Excelsior

For over 45 years Marshall Excelsior Company has been a progressive manufacturer of top quality and competitively priced LPG & NH3 equipment that is leading the industry in innovation and low emission products. We offer a full range of products that support the LPG & NH3 Bulk Plant, Transport, Delivery/Dispensing, and Domestic applications. As our product line continues to grow, we are striving to improve product functionality while taking the industry standards to a higher level of quality and performance without adding excessive cost. While following along this path, our engineering staff exercises a heavy reliance on the input from our customers throughout any new product design phase. It has been through these theories and approaches that we have been able to carve out our niche in an industry where safety and performance must work hand-in-hand. Our goal is to create the safest equipment solutions for everyday operations while allowing the largest amount of product to be transferred, dispensed, or otherwise used, resulting in an overall savings to the customer.

In addition to our company philosophy for new product development, you will find our approach to daily operations equally unique. In a time where materials, fuels, and other manufacturing costs are on the rise, we have not only remained competitive, but one of the industry leaders in on-time deliveries and short lead-times. The reason is simple; we not only manufacture our products effectively, but carry one of the most extensive on-hand inventories available in the industry. This allows our distributors to react quickly without having an excessive amount of stock on hand. Put this together with our proactive, responsive sales and customer service staff and you have a winning combination.

As one of the industry leaders in responsiveness it is essential for our organization to be able to react in a rapid fashion, hence our fully integrated manufacturing and purchasing process. Our capabilities in manufacturing range from high volume to custom made product. Both of which are supported by our wide variety of manufacturing equipment, highly skilled personnel, and dedicated purchasing staff. Combine these attributes with our top notch ISO9001 quality system and you have a combination that easily rivals that of our nearest competition.

Over the course of time Marshall Excelsior Company has become a name that our customers can rely on not only for high quality products and services, but as a partner in building their business. Together, with our commitment to the industries served and our eagerness to improve and expand our product-line our customers routinely find the opportunity to promote our organization. It is through this personal touch that our family owned and operated business has become the organization that it is today. We are confident that as our company continues to develop and mature in our industries, Marshall Excelsior Company will become a brand of choice.



w w w . e y o n a g a s . c o . z a

0 2 1 5 5 1 5 6 9 9 - 0 1 1 8 6 8 1 4 9 4

MARSHALL EXCELSIOR REGULATORS



E y o n a G a s E q u i p m e n t

w w w . e y o n a g a s . c o . z a

0 2 1 5 5 1 5 6 9 9 - 0 1 1 8 6 8 1 4 9 4



w w w . e y o n a g a s . c o . z a

0 2 1 5 5 1 5 6 9 9 - 0 1 1 8 6 8 1 4 9 4

MARSHALL EXCELSIOR REGULATORS

COMMERCIAL / INDUSTRIAL
HIGH PRESSURE



E y o n a G a s E q u i p m e n t

w w w . e y o n a g a s . c o . z a

0 2 1 5 5 1 5 6 9 9 - 0 1 1 8 6 8 1 4 9 4



COMMERCIAL/INDUSTRIAL HIGH PRESSURE

DESCRIPTION	CODE	INLET & OUTLET	OUTLET PRESSURE
MEGR-1112H-AAJ 24kg/hr		1/4" FNPT x 1/2" FNPT	54 - 81kpa
MEGR-1622H-DGJ 54kg/hr	180803	3/4" FNPT	54 - 81kpa
MEGR-130-20 20kg/hr	180826	1/4" FNPT	1.2bar
MEGR-6120-30 20kg/hr ADJ	180376	1/4" FNPT	0.34 - 2bar
MEGR 164V-35 Hp 130kg/hr		1/2" FNPT	0.34 - 2bar
MEGR 164V-6/35 HP 200kg/hr		3/4" FNPT	0.34 - 2bar
MEGR-1627-7710 400kg/hr		1" FNPT	0.34 - 1.36bar
MEGR-1627-576 900kg/hr		2" FNPT	0.34 - 1.36bar



MEGR-164V-6/35
Code:



MEGR-130-20
Code: 180826

COMMERCIAL / INDUSTRIAL HIGH PRESSURE

DESCRIPTION	CODE	INLET & OUTLET	OUTLET PRESSURE
MEGR- 1630-104/78 1000kg/hr		2" FNPT	0.55 – 1.4bar
MEGR-1299H-104 800kg/hr		2" FNPT	0.41 – 1.1bar
MEGR-199-901PH w/pilot 2000kg/hr	160030	2" FNPT	0.69 – 4.5bar
MEGR-199F-901PH w/pilot 2000kg/hr	180530	2" 300# Flanged	0.69 – 4.5bar
MEGR- 1298H BACK PRESSURE Reg		1" FNPT	



MEGR-1298H
Code:



MEGR-199F-901
Code: 160030

w w w . e y o n a g a s . c o . z a

0 2 1 5 5 1 5 6 9 9 - 0 1 1 8 6 8 1 4 9 4

MARSHALL EXCELSIOR REGULATORS

2 N D S T A G E / L O W P R E S S U R E



E y o n a G a s E q u i p m e n t

w w w . e y o n a g a s . c o . z a

0 2 1 5 5 1 5 6 9 9 - 0 1 1 8 6 8 1 4 9 4



2ND STAGE / LOW PRESSURE

DESCRIPTION	CODE	INLET & OUTLET	OUTLET PRESSURE
MEGR-1222-BAF 10kg/hr		½" FNPT	2.4 – 3.2kpa
MEGR-1622-BCF 20kg/hr		½" FNPT	2.4 – 3.2kpa
MEGR-1622-DFF 30kg/hr		¾" FNPT	2.4 -3.2kpa
MEGR-1622C-GGF 44kg/hr	180345	1" FNPT	2.4kpa – 3.2kpa
MEGR-1HSRL-CFC 54kg/hr		1" FNPT	2.2 – 3.2kpa



MEGR-1622-DFF
Code:

COMMERCIAL / INDUSTRIAL LOW PRESSURE

DESCRIPTION	CODE	INLET & OUTLET	OUTLET PRESSURE
MEGR-1299H-102 400kg/hr		2" FNPT	2.2 - 5kpa
MEGR-1133L-4 1420kg/hr		2" FNPT	2.1 -4.5kpa



MEGR-133L-4F

Code:

w w w . e y o n a g a s . c o . z a

0 2 1 5 5 1 5 6 9 9 - 0 1 1 8 6 8 1 4 9 4

MARSHALL EXCELSIOR REGULATORS

TWIN STAGE (TANK PRESSURE
TO 2.8 KPA) + AUTO CHANGE
OVERS

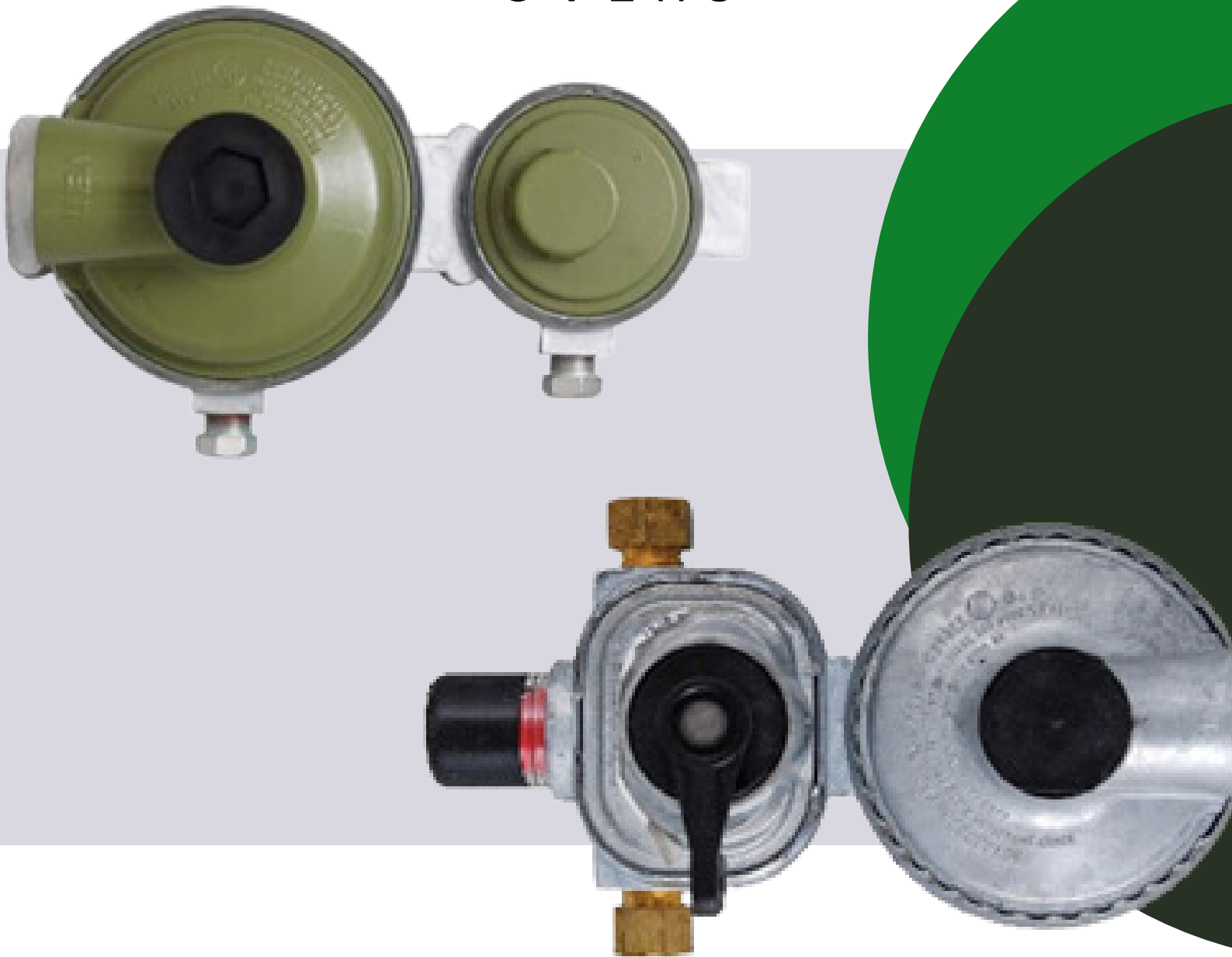

E y o n a G a s E q u i p m e n t

w w w . e y o n a g a s . c o . z a

0 2 1 5 5 1 5 6 9 9 - 0 1 1 8 6 8 1 4 9 4



TWIN STAGE (TANK PRESSURE TO 2.8KPA) + AUTO CHANGE OVERS

DESCRIPTION	CODE	INLET & OUTLET	OUTLET PRESSURE
MEGR-1232-BBF 10kg/hr		1/4" FNPT x 1/2" FNPT	2.4 - 3.2kpa
MEGR-291 Two Stage 6kg/hr	180808	1/2" x 3/8" FNPT	2.8kpa
MEGR-253H Auto Change Over	180825	14" INV Flare x 3/8"	2.8kpa
MEGR-175cs HP AUTO CHANGE OVER 20kg/hr	180919	1/4" INV Flare	70kpa



MEGR-291
Code: 180808



MEGR-253H
Code: 180825

COMMERCIAL/ INDUSTRIAL REGULATOR REPAIR KITS

DESCRIPTION	CODE
MEGR1627-SRK REGULATOR REPAIR KIT	180847
Fisher Repair Kit 627X000A12	160033
Fisher Repair Kit 6353X00012 Pilot Repair Kit For 1098 REG	180158
Fisher Repair Kit 63EGX00122 Actuator	180153

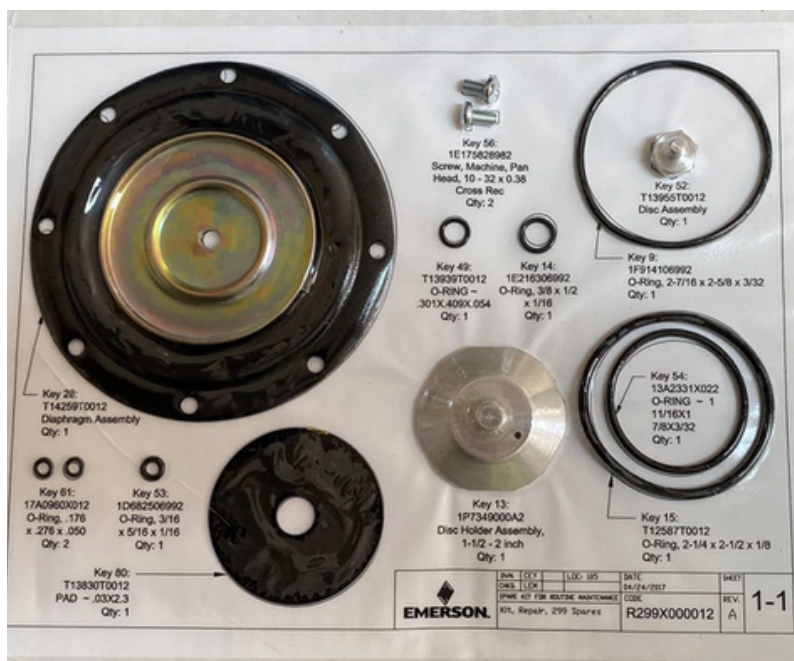

Fisher 299HX
Code: 180098

COMMERCIAL/ INDUSTRIAL REGULATOR REPAIR KITS

DESCRIPTION	CODE
Fisher Repair Kit R1098X00402 Regulator	180154
Fisher Repair Kit R299HX	180098
Fisher Repair Kit R99HX000022	180102
Fisher Repair Kit RS201X0012	1801021
Fisher Repair Kit R64X0000012	160035
MEGR 164V-03-06 SRK Regulator Repair Kit	180865

w w w . e y o n a g a s . c o . z a

0 2 1 5 5 1 5 6 9 9 - 0 1 1 8 6 8 1 4 9 4

METRIX + GNALI REGULATORS

U P S O O P S O (U N D E R P R E S S U R E
O V E R P R E S S U R E P R O T E C T I O N)

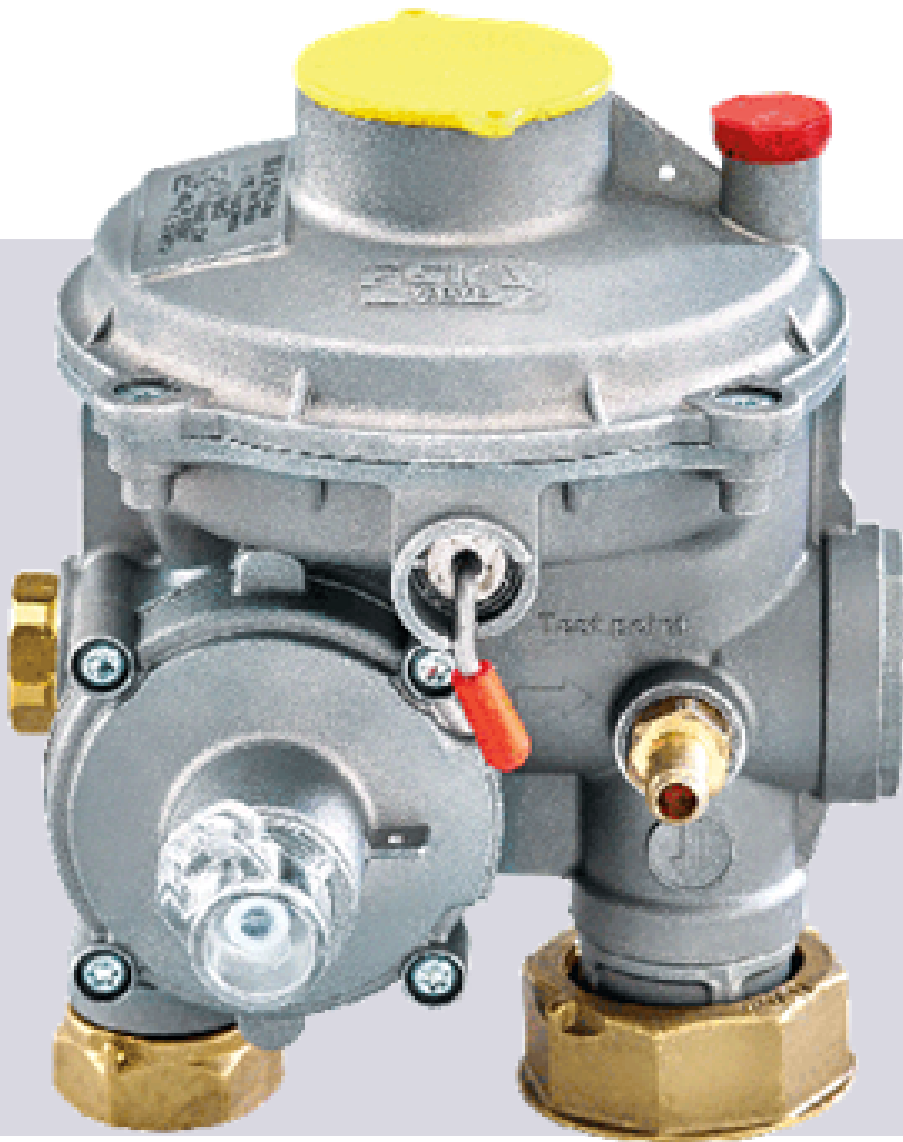

E y o n a G a s E q u i p m e n t

w w w . e y o n a g a s . c o . z a

0 2 1 5 5 1 5 6 9 9 - 0 1 1 8 6 8 1 4 9 4



SINGLE STAGE + HP REG

DESCRIPTION	CODE	INLET & OUTLET	OUTLET PRESSURE
Mondial Red Baron 4kg/hr	180007	1/4" FNPT x 3/8" FNPT	2.4 - 3.2kpa
Mondial Big Baron 10kg/hr	180099	1/2" FNPT	2.8kpa
Mondial HP 12kg/hr Adj	180009	1/4" FNPT	.30 - 4bar



UPSO OPSO (UNDER PRESSURE OVER PRESSURE PROTECTION)

DESCRIPTION	CODE	INLET & OUTLET	OUTLET PRESSURE
UPSO OPSO DSR10 10kg/hr	160095	Multi config	2.4 to 4.5kpa
UPSO OPSO DSR25 25kg/hr	180229	Multi config	2.4 to 4.5kpa
UPSO OPSO DSR50 50kg/hr	180390		2.4 to 4.5kpa
Alfa Block Slam Shut 1-3bar	180715	2" FNPT	1.5bar
Alfa Block Slam Shut 1-3bar	180858	4" FNPT	1.5bar



LASER ENGRAVED LABELLING



PAINTED COATING FOR UNDERGROUND INSTALLMENT



TEST PORT



SEALED PLASTIC CAP



SEALING HOLES ON CONNECTIONS

UPSO OPSO DSR25
 Code: 180229



REGULATOR ACCESSORIES + MISC

DESCRIPTION	CODE	INLET & OUTLET	OUTLET PRESSURE
Manual Change over valve	180008	1/4" x 1/4"	
Man Change w/reg , bracket & pigtails 4kg/hr	160096	Outlet 3/8"	
Man Change w/reg , bracket & pigtails 10kg/hr	180164	Outlet 1/2"	
Mounting bracket P100A for reg: (R622, R632, R622H, R122H, R222, R912)	160043		
Universal Bracket	180011		
ME900 Universal Bracket	180804		
Fisher Spring 622 20 - 35 WC T14402T0012	160062		5- 8.9kpa

TRUCK & PLANT EQUIPMENT

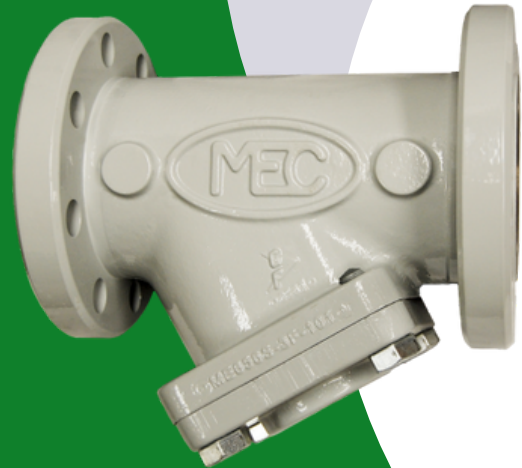

E y o n a G a s E q u i p m e n t

w w w . e y o n a g a s . c o . z a

0 2 1 5 5 1 5 6 9 9 - 0 1 1 8 6 8 1 4 9 4



TRUCK & PLANT EQUIPMENT

Y - STRAINERS DUCTILE IRON

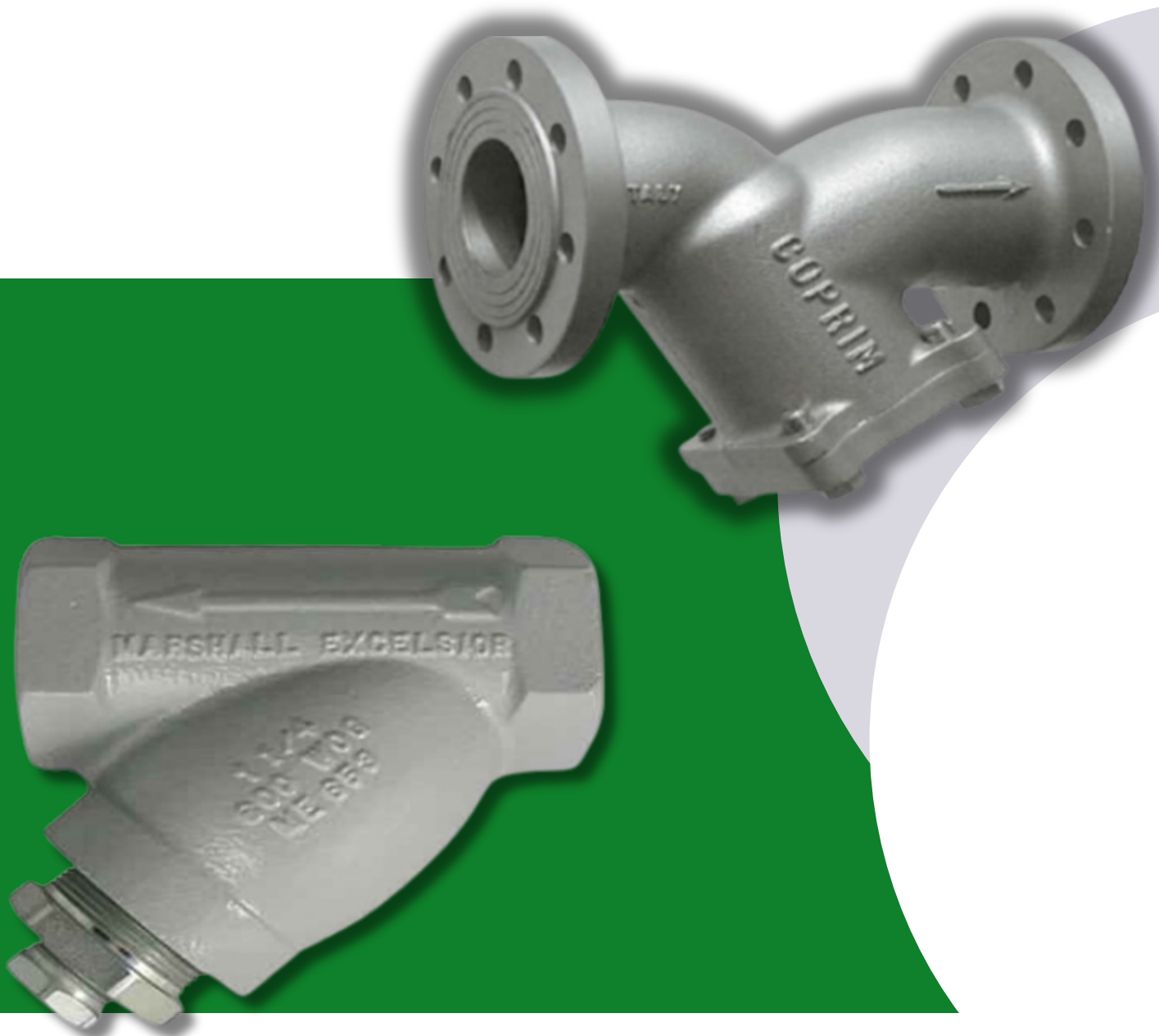

E y o n a G a s E q u i p m e n t

w w w . e y o n a g a s . c o . z a

0 2 1 5 5 1 5 6 9 9 - 0 1 1 8 6 8 1 4 9 4



Y-STRAINERS DUCTILE IRON

DESCRIPTION	CODE	SIZE
Marshall ME650S	180063	1/2" x 1/2" FNPT
Marshall ME651S	180064	3/4" x 3/4" FNPT
Marshall ME652S	180166	1" x 1" FNPT
Marshall ME653S	180113	1 1/4" x 1 1/4" FNPT
Marshall ME654S	180374	1 1/2" x 1 1/2" FNPT
Marshall ME655S	180352	2" x 2" FNPT
Marshall ME655SP-2F		2" 300-pound Flanged
Marshall ME656SP-3F		3" 300-pound Flanged
Marshall ME656SP-4F		4" 300-pound Flanged



ME651S
Code: 180064



ME656SP-3F
Code:

TRUCK & PLANT EQUIPMENT

GLOBE VALVES STRAIGHT

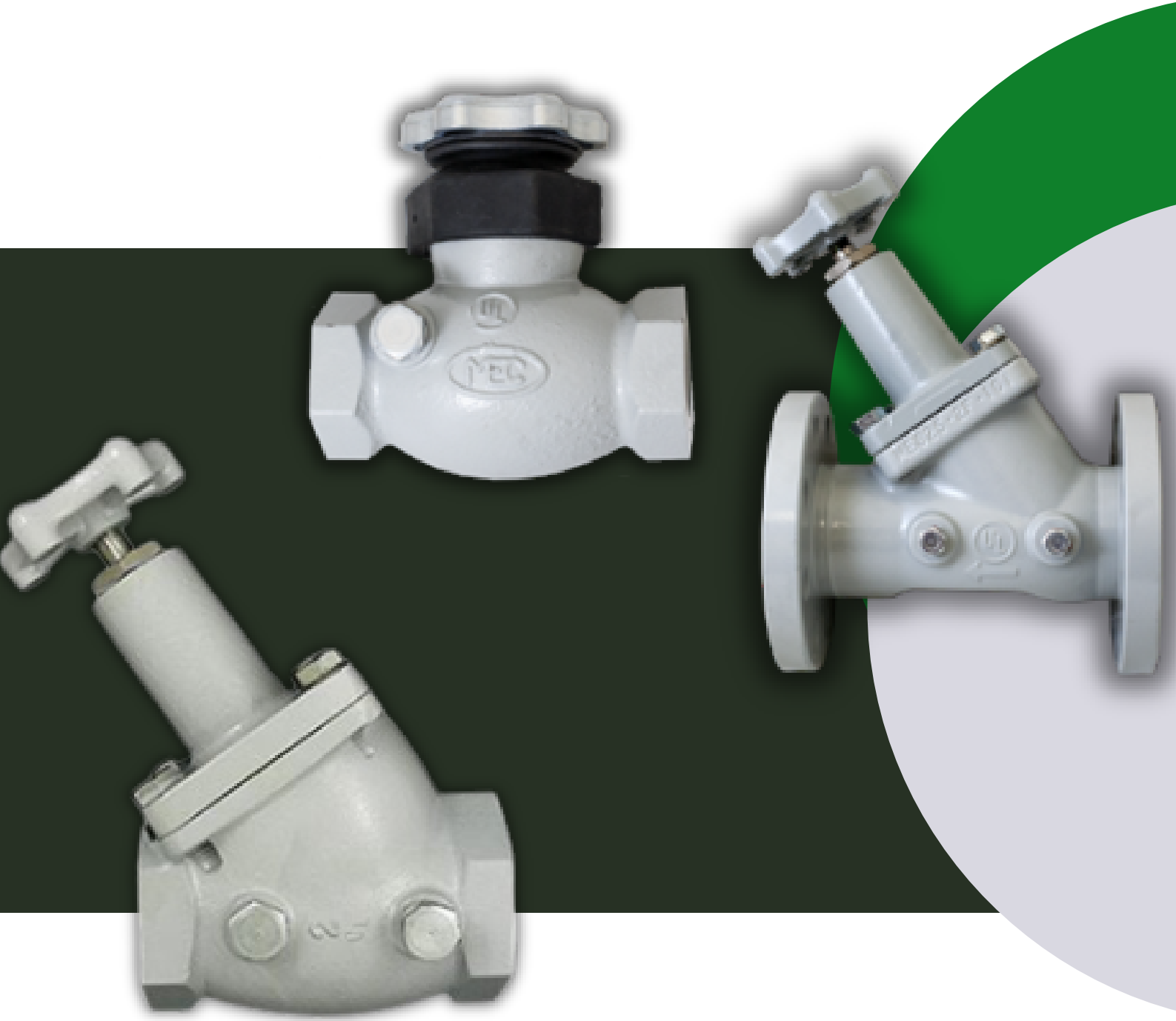

E y o n a G a s E q u i p m e n t

w w w . e y o n a g a s . c o . z a

0 2 1 5 5 1 5 6 9 9 - 0 1 1 8 6 8 1 4 9 4



GLOBE VALVES STRAIGHT

DESCRIPTION	CODE	INLET & OUTLET
Marshall ME825-4	180058	1/2" FNPT
Marshall ME825-6	180060	3/4" FNPT
Marshall ME825-8	180059	1" FNPT
Marshall ME825-10	180124	1 1/4" FNPT
Marshall ME825-16	180225	2" FNPT
Marshall ME825-2F 2" 300# FLANGED	180522	2" 300# Flanged
Marshall ME825-3F 3" 300# FLANGED	180520	3" 300# Flanged



ME825-8
Code: 180059



ME825-10
Code: 180124

TRUCK & PLANT EQUIPMENT

GLOBE VALVES ANGLED



E y o n a G a s E q u i p m e n t

w w w . e y o n a g a s . c o . z a

0 2 1 5 5 1 5 6 9 9 - 0 1 1 8 6 8 1 4 9 4



GLOBE VALVES ANGLED

DESCRIPTION	CODE	INLET & OUTLET
Marshall ME815-4	180315	1/2" FNPT
Marshall ME815-6	180313	3/4" FNPT
Marshall ME815-8	180314	1" FNPT
Marshall ME815-10	180179	1 1/4" FNPT
Marshall ME815-2F 2" 300# FLANGED	180519	2" 300# Flanged
Marshall ME815-3F 3" 300# FLANGED	180521	3" 300# Flanged



ME815-6
Code: 180313



ME815-10
Code: 180179

TRUCK & PLANT EQUIPMENT

BYPASS VALVES



E y o n a G a s E q u i p m e n t

w w w . e y o n a g a s . c o . z a

0 2 1 5 5 1 5 6 9 9 - 0 1 1 8 6 8 1 4 9 4



Bypass Valves

Description	Code	Spring Range	Size
ME840-8-150 ByPass	180341	3 - 10 Bar	1"FNPT
ME840-10-125 ByPass	180342	6 - 10.5 Bar	1 1/4"FNPT
ME840-12-125 ByPass	180342	6 - 10.5 Bar	1 1/2"FNPT
ME840-16-150 ByPass	180343	6 - 10.5 Bar	2"FNPT
ME840-24-100 ByPass	180494	0 - 10 Bar	3" FNPT
ME840-24-3F-100 ByPass Flanged High Volume	180445	3.5 - 7 Bar	3" 300# Flanged



ME840-8-15
Code: 180341



ME840-16-150
Code: 180343

TRUCK & PLANT EQUIPMENT

BACK CHECK VALVES

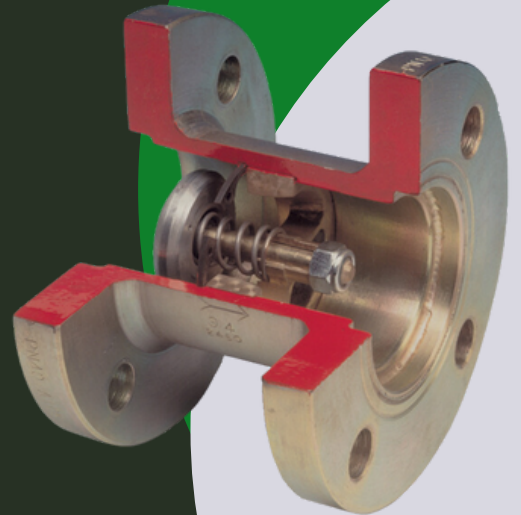

E y o n a G a s E q u i p m e n t

w w w . e y o n a g a s . c o . z a

0 2 1 5 5 1 5 6 9 9 - 0 1 1 8 6 8 1 4 9 4



Back Check Valves

Description	Code	Size
Back Check Manifold Style	17000	1/4"
Cop Back Check	5005	1" 300# Flanged
Cop Back Check	5006	1" PN40 Flanged
Cop Back Check	5010	1 1/2" 300# Flanged
Cop Back Check	5007	1 1/2" PN40 Flanged
Cop Back Check	180841	2" 300# Flanged
Cop Back Check	50071	2" PN40 Flanged
Cop Back Check	5008	3" 300# Flanged
Cop Back Check	180835	4" 150# Flanged
Cop Back Check	180844	6" 300# Flanged

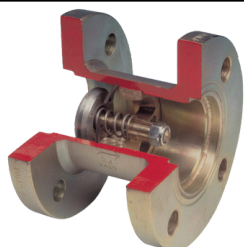

Cop Back Check
Code: 5010

Back Check Valves cont.

Cop Back Check for bulk tank	180137	1 1/2" MNPT x 1 1/4" FNPSM
ME3400-16	1804481	2"
ME870-10	180498	1-1/14" FNPT x 1-1/4" MNPT
ME870-16	180397	2" FNPT x 2" MNPT
ME870-6	180499	3/4" FNPT x 3/4" MNPT
ME870S-10	180975	1 1/4" FNPT x 1 1/4" MNPT
ME870S-12		1 1/2" FNPT x 1 1/2" MNPT
ME870S-16	180448	2" FNPT x 2" MNPT
ME870S-24	180816	3" FNPT x 3" MNPT
ME870S-6	18014	3/4" FNPT x 3/4" MNPT
ME870SS-16	130101	2" FNPT x 3" MNPT

TRUCK & PLANT EQUIPMENT

EXCESS FLOW VALVES

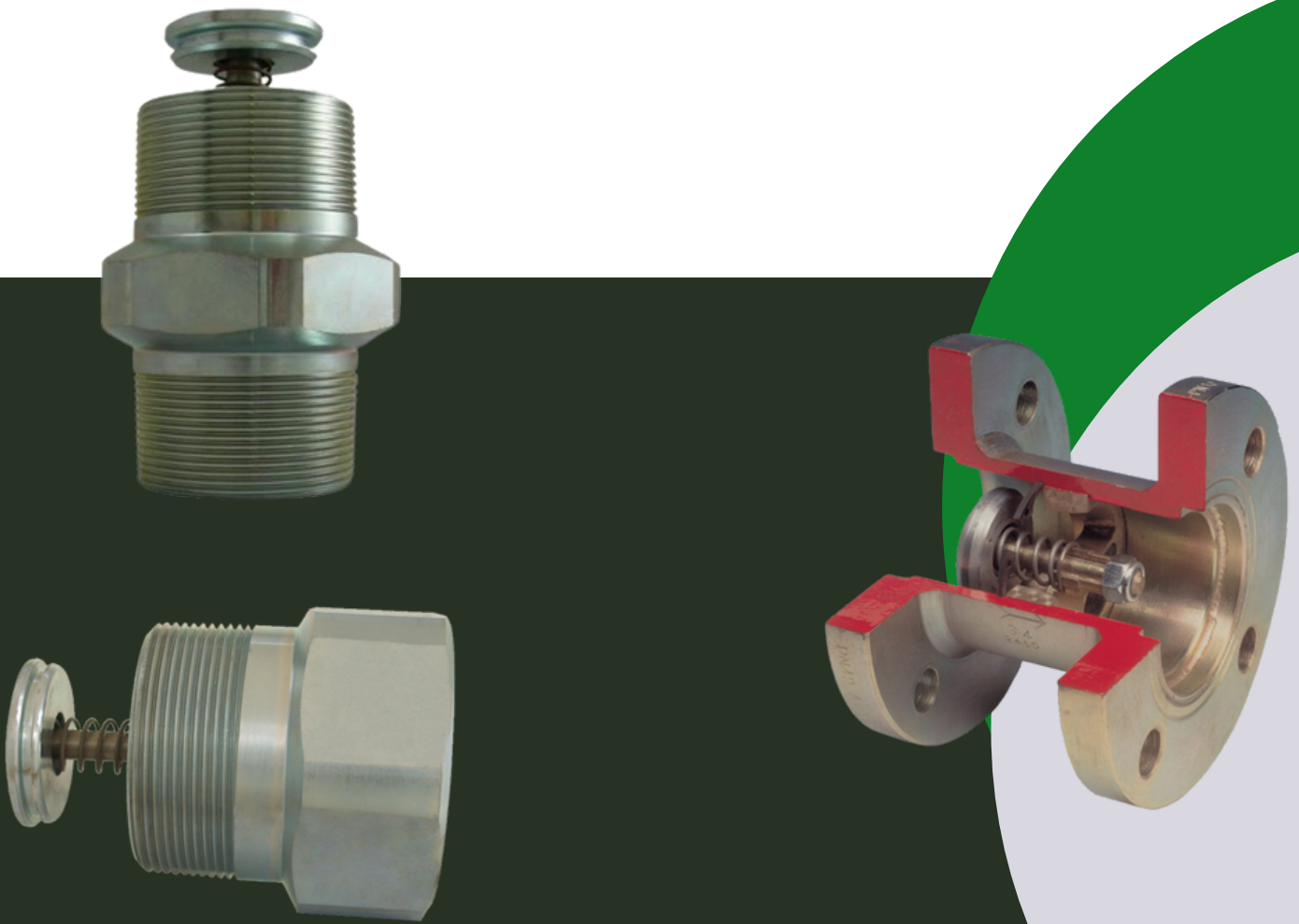

E y o n a G a s E q u i p m e n t

w w w . e y o n a g a s . c o . z a

0 2 1 5 5 1 5 6 9 9 - 0 1 1 8 6 8 1 4 9 4



Excess Flow Valves

Description	Code	Size
Cop Excess Flow DN25	5000	1" 300# Flanged
Cop Excess Flow DN25	5001	1" PN40 Flanged
Cop Excess Flow DN40	5009	1 1/2" 300# Flanged
Cop Excess Flow DN40	5003	1 1/2" PN40 Flanged
Cop Excess Flow F/R: @3,5bar 375lpm	180839	2" 300# Flanged
Cop Excess Flow F/R: @3,5bar 375lpm	5004	2" PN40 Flanged
Cop Excess Flow F/R: @3,5bar 533lpm	180040	3" 300# Flanged
Cop Excess Flow F/R: @3,5bar 667lpm	180917	4" 300# Flanged
Cop Excess Flow F/R: @3,5bar **lpm	180846	6" 300# Flanged
Excess Flow Valve STEEL	180227	1 1/4" x 1 1/4" MNPT M/M
Excess Flow Valve STEEL	160093	1 1/4" x 3/4" MNPT M/M
ME3600-24/250 Excess Flow Internal S/Steel	180462	3" x 3" MNPT

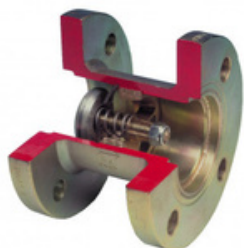

Coprim Excess Flow DN25
Code: 5000

Excess Flow Valves cont.

Description	Code	Size
ME880-6/28 Excess Flow Brass	180495	3/4" FNPT x 3/4" MNPT
ME880-10/42 Excess Flow Brass	180462	1 1/4" FNPT x 1 1/4" MNPT
ME880-16/80 Excess Flow Brass	180500	2" FNPT x 2" MNPT
ME880-16/114 Excess Flow Brass	180502	2" FNPT x 2" MNPT
ME880S-6 Excess Flow Steel	180112	3/4" FNPT x 3/4" MNPT
ME880S-10/42 Excess Flow Steel	180814	1 1/4" FNPT x 1 1/4" MNPT
ME880S-16/80 Excess Flow Steel	180111	2" FNPT x 2" MNPT
ME880S-24/250 Excess Flow Steel	180503	3" FNPT x 3" MNPT
ME880SS-16/140 Excess Flow S/Steel	130100	2" FNPT x 2" MNPT
ME882S-16/114 Excess Flow Steel	180375	2" MNPT M/M

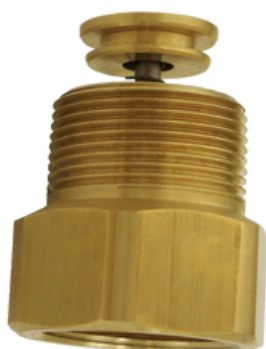

ME880-10/42
Code: 180462



ME880S-10/42
Code: 180814



ME882S-16/114
Code: 180375

TRUCK & PLANT EQUIPMENT

SIGHT FLOW VALVES

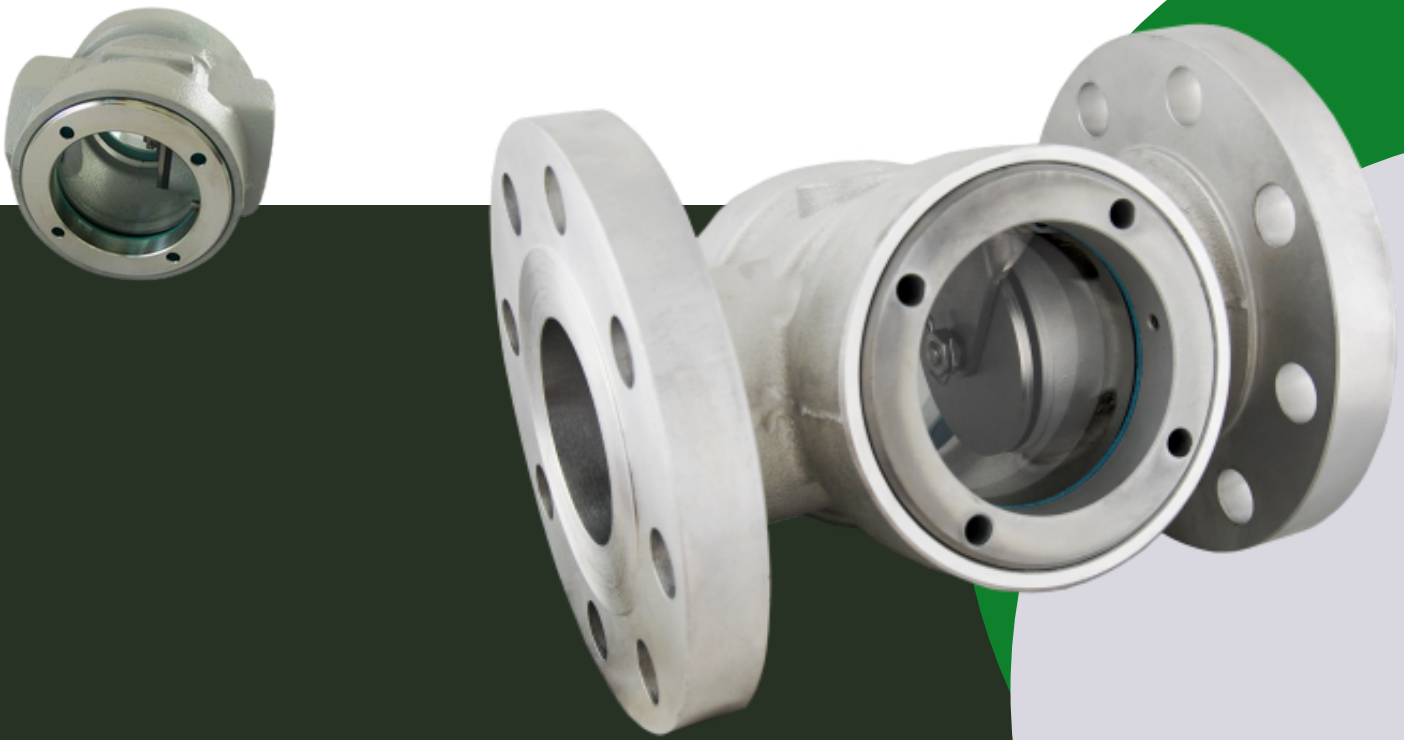

E y o n a G a s E q u i p m e n t

w w w . e y o n a g a s . c o . z a

0 2 1 5 5 1 5 6 9 9 - 0 1 1 8 6 8 1 4 9 4



Sight Flow Indicators

Description	Code	Size
Sight Flow Brass for Cadac Pumps	160069	1/2" FNPT
ME875S-16 Sight Flow Valve w/swing check	180055	2" FNPT
ME875S-24 Sight Flow Valve w/swing check	180355	3" FNPT
ME875S-3F Sight Flow Valve w/swing check	1803551	3" Flanged



ME875S-16
Code: 180055

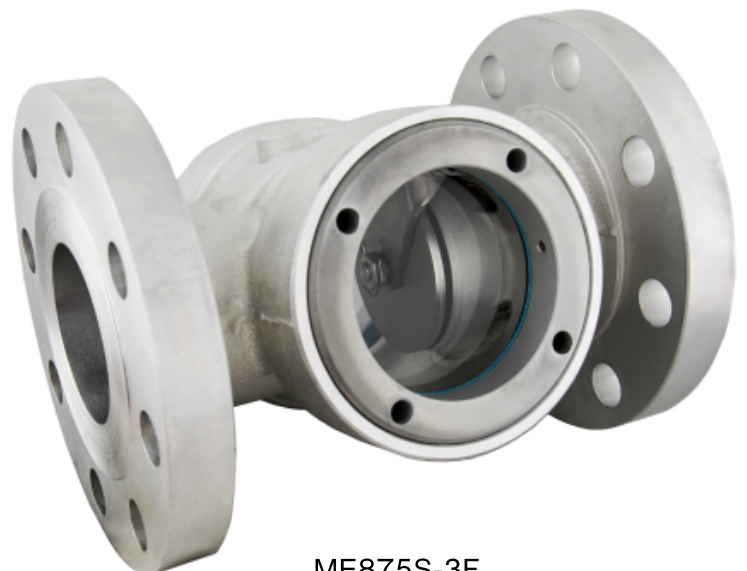

ME875S-3F
Code: 1803551

TRUCK & PLANT EQUIPMENT

FILLER COUPLINGS & VALVES



E y o n a G a s E q u i p m e n t

w w w . e y o n a g a s . c o . z a

0 2 1 5 5 1 5 6 9 9 - 0 1 1 8 6 8 1 4 9 4



Filler Couplings & valves

Description	Code	Material	Size
ME106-1 CAP & CHAIN	180965		3 ¼" F
ME109-1 CAP & CHAIN	180973		1 ¾" F
ME111S	1800	Steel	1 ¾" F x ¾" MNPT
ME112	180446	Brass	1 ¾" F x 1" MNPT
ME112S	180066	Steel	1 ¾" F x 1" MNPT
ME121S	1805		2 ¼" x 1 ½" MNPT
ME130B	1806		3 ¼" x 2" MNPT
ME130S Steel Adaptor F ACME	180963		3 ¼" x 2" MNPT
ME151		Brass	1 ¾" F x 1" MNPT
ME215S		Steel	1 ¾" x ¾" M
ME216S	180829	Steel	1 ¾" x 1" M

Filler Couplings & valves cont

ME217S	180813	Steel	1 3/4" x 1 1/4" M
ME252S-16 Steel Adaptor M ACME	180964	Steel	3 1/4" M x 2" FNPT
ME262S Steel Adaptor M ACME	180134	Steel	3 1/4" x 3" MNPT
ME390S Extended bullnose	180223		2 1/4" x 10/8 F/MNPT
ME130B	1806		3 1/4" x 2" MNPT
ME130S Steel Adaptor F ACME	180963		3 1/4" x 2" MNPT
ME151		Brass	1 3/4" F x 1" MNPT
ME215S		Steel	1 3/4" x 3/4" M
ME216S	180829	Steel	1 3/4" x 1" M

Filler Couplings & valves cont.

ME502S-16/10 Steel Adaptor M ACME	1803		2 1/4" x 10/8 F/MNPT
ME503S-16 Steel Adaptor M ACME	1801		3 1/4" X 2" MNPT
ME503SJS-16 Low Emission ACME Connector	1810		3 3/4"MACME
ME664 Vapour Return Valve W/Cap			1 3/4" x 1 1/4" MNPT
ME601-10 Double Check Filler Valve, Cap	180316		1 3/4" x 1 1/4" MNPT
ME601- 6 Double Check Filler Valve, Cap	180171		3 1/4" x 3/4" MNPT
ME612S ACME REDUCER	180968		3 1/4" x 1 3/4" M.ACME
ME635-8 filler coupling	180067		1 3/4" x 1" MNPT

Filler Couplings & valves cont.

ME790 Extended forklift filler	180068		
ME791C quick acting valve	180069		1/2" x 1/4"
ME791D quick acting valve	180070		1/2" x 1/2"
ME800 Hose end filler	180077		1 3/4"
ME806-16 Low Emission Transfer	180700		3 1/4" x 2" FNPT
ME646-8 vapor return coupling			1 3/4" x 1" MNPT
ME777-4 Quick Acting Bullnose	160020		Bullnose x 1/2"

Filler Couplings & valves cont.

ME831 Needle Valve	180339		1/4" x 1/4"
ME850SS-8 Hose End Swivel	180173		1" FNPT x 1" MNPT
ME868-16 Low Emission with Excess Flow	180967		3 1/4 x 2" MNPT
MEP102B ACME Spanner ALU	180966		1 3/4", 2 1/4", 3 1/4", 4 1/4"
ME503JT-16 vent hole	180651		2NPT x 3 1/4"
MEP502 Acme strainer 30mesh	160082		1 3/4"M.Acme x 1 3/4"F.Acme
ME229FS-1 Dust Cap ACME with chain	180167		1 3/4"

TRUCK & PLANT EQUIPMENT

SMALL RELIEF VALVES



E y o n a G a s E q u i p m e n t

w w w . e y o n a g a s . c o . z a

0 2 1 5 5 1 5 6 9 9 - 0 1 1 8 6 8 1 4 9 4



SMALL RELIEF VALVES

DESCRIPTION	CODE	SIZE	SET PRESSURE
MEV25/250 Relief Valve	180461	1/4" MNPT	17,24bar
MEV50/250 Relief Valve	180198	1/2" MNPT	17,24bar
MEV75/250 Relief Valve	180501	3/4" MNPT	17,24bar
MEVS-PVE431B/250 Vap Relief Valve	180961	3/4" MNPT	17,24bar
MEH225/350 Relief Valve	180126	1/4" MNPT	23,8bar
MEH225SS/350 Relief Valve STAINLESS STEEL	180870	1/4" MNPT	23,8bar



MEV25/250
Code: 180461



MEVS-PVE431B/250
Code: 180461

SMALL RELIEF VALVES

DESCRIPTION	CODE	SIZE	SET PRESSURE
MEH75/350 Relief Valve	180180	3/4" MNPT	23,8bar
MEPS-431 PIPE AWAY VAP PRV (MEVS-PVE431B)	180449	FOR MEVS-PVE431B	
MEP173 PIPE AWAY for 1/4"	180860	FOR 1/4" Relief Valves	
Direct Fired 3/4" Relief Valve	160018	3/4" MNPT	17,24bar
COP Relief Valve Mini	180082	1/4" MNPT	17,24bar

TRUCK & PLANT EQUIPMENT

LARGE RELIEF VALVES (BULK
TANKS + TRUCKS)



E y o n a G a s E q u i p m e n t

w w w . e y o n a g a s . c o . z a

0 2 1 5 5 1 5 6 9 9 - 0 1 1 8 6 8 1 4 9 4



LARGE RELIEF VALVES (BULK TANKS + TRUCKS)

DESCRIPTION	CODE	SIZE	SET PRESSURE
Marshall MEV200FIR/250 Full Internal Relief Valve	180346	2" MNPT	17,24bar
Marshall MEV300FIR/250 Full Internal Relief Valve		3" MNPT	17,24bar
Marshall MEV200SIR/250 Semi Internal Relief Valve		2" MNPT	17,24bar
Marshall MEV300FIR/250 2" Full Internal Relief		3" 300# Flanged	17,24bar



MEV200FIR/250
Code: 180346

LARGE RELIEF VALVES (BULK TANKS + TRUCKS)

DESCRIPTION	CODE	SIZE	SET PRESSURE
MEV300FIR-09 3" FIR Dust Cover Cap	333		
MEV250CN Ext. Relief Valve (MULTIPOINT PRV)	180178	2 ½" MNPT	17,24bar
COP Relief Valve SV30 1 1/4" (9m3 PRV)	180133	1 ¼" NPSM	17,24bar
COP Pipe Away for SV30 1 1/4" Relief valve	180208	1 ¼" NPSM	
COP RELIEF VALVE GASKET FOR SV30	180138		



MEV250CN Ext. Relief
Code: 180178

TRUCK & PLANT EQUIPMENT

MULTI PORT + BULK RELIEF VALVE



E y o n a G a s E q u i p m e n t

w w w . e y o n a g a s . c o . z a

0 2 1 5 5 1 5 6 9 9 - 0 1 1 8 6 8 1 4 9 4



MULTIPOINT + BULK RELIEF VALVE

DESCRIPTION	CODE	SIZE	SET PRESSURE
ME903S-4F/250VM MultiPort 4" Flanged with 3 Relief Valves	180226	4" 300# Flanged	17,24bar
ME904S-4F/250VM MultiPort 4" Flanged C/W 4 Relief Valves	180190	4" 300# Flanged	17,24bar
ME904S-16 Mini Multi Port (LPG/NH3)	1801901	2" MNPT	17,24bar
Fisher 63EGLP-EB3 4" Bulk Relief Valve w/Pilot	160097	4" 300# Flanged	17,24bar



ME904S-4F/250VM MultiPort
Code: 180190



Fisher 63EGLP-EB3 4"
Bulk Relief Valve w/Pilot
Code: 160097

SPARES

DESCRIPTION	CODE	SIZE	SET PRESSURE
Fisher 6358EBLP-EB3 Pilot Reg Set	180004		
Fisher 63EGLPX012 Repair Kit Main Body	180101		
Fisher 6358EBLP-3 Pilot Repair Kit			
Fisher 6358ELBP Pilot Spring Red 6358EBLP-3 12,4 - 24,1 Bar			

TRUCK & PLANT EQUIPMENT

EMERGENCY SHUT OFF VALVES

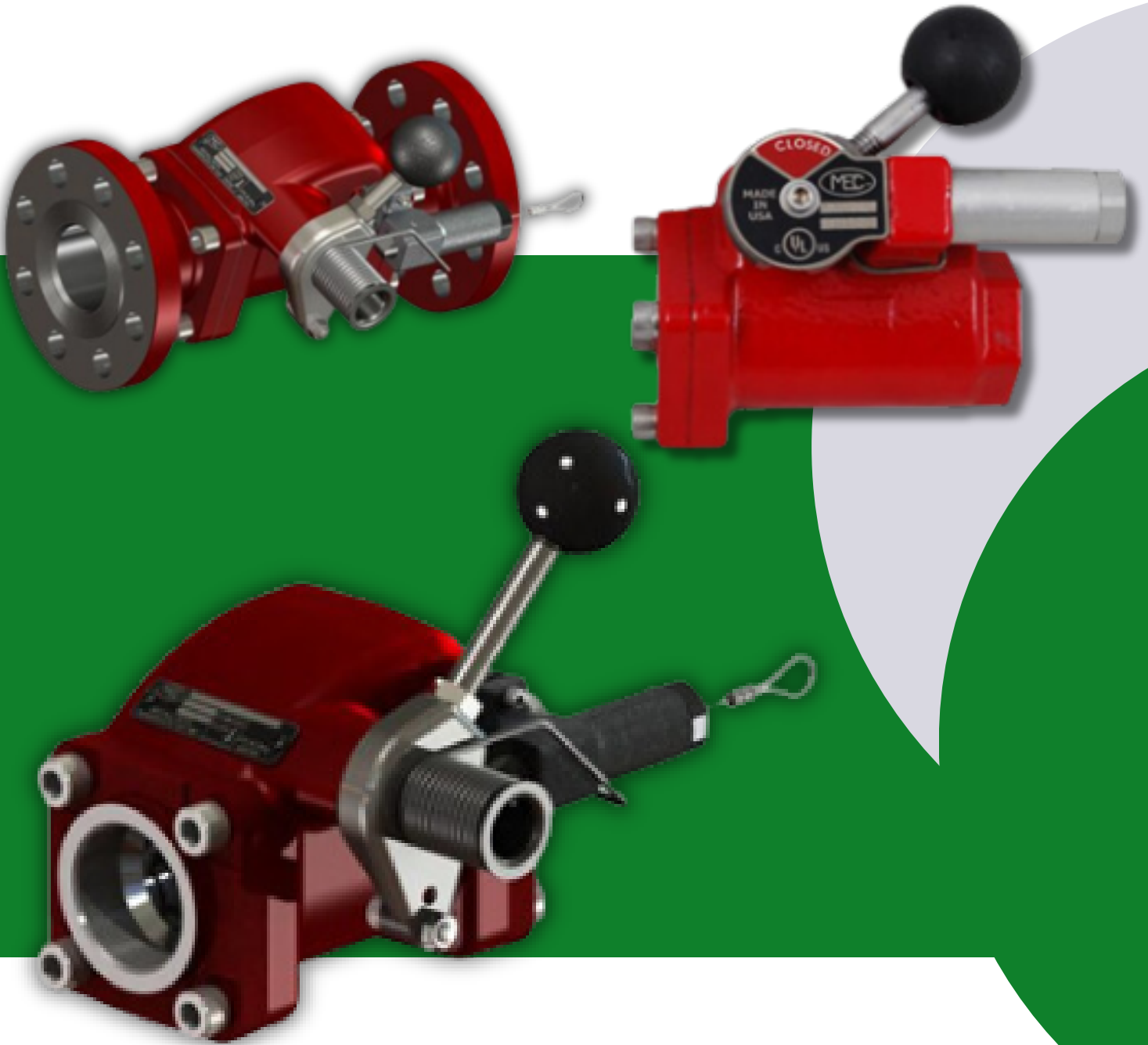

E y o n a G a s E q u i p m e n t

w w w . e y o n a g a s . c o . z a

0 2 1 5 5 1 5 6 9 9 - 0 1 1 8 6 8 1 4 9 4



EMERGENCY SHUT OFF VALVES

DESCRIPTION	CODE	SIZE	SET PRESSURE
Marshall ME980-6 Pneumatic Latch	180333	3/4" FNPT	Pneumatic
Marshall ME980-8 Pneumatic Latch	180335	1" FNPT	Pneumatic
Marshall ME980-10 Pneumatic Latch		1 1/4" FNPT	Pneumatic
Marshall ME980-24 Pneumatic Latch		3" FNPT	Pneumatic
Marshall ME980-16-2F 2" 300# Flanged Pneumatic	1803992	2" 300# Flanged	Pneumatic
Marshall ME980-24-3F 3" 300# Flanged Pneumatic		3" 300# Flanged	Pneumatic
Marshall ME980-24-4F 4" 300# Flanged Pneumatic		4" 300# Flanged	Pneumatic



ME980-8
Code: 180333

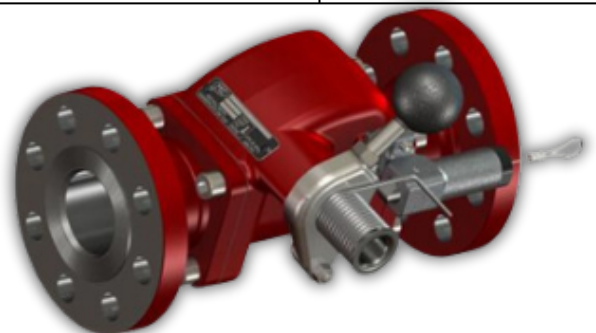

ME980C-24-3F
Code: 180333

EMERGENCY SHUT OFF VALVES

DESCRIPTION	CODE	SIZE	SET PRESSURE
Marshall ME980C-6 Cable Latch	180334	3/4" FNPT	Cable Latch
Marshall ME980C-8 Cable Latch	180336	1" FNPT	Cable Latch
Marshall ME980C-10 Cable Latch		1 1/4" FNPT	Cable Latch
Marshall ME980C-16 Cable Latch		2" FNPT	Cable Latch
Marshall ME980C-24 Cable Latch		3" FNPT	Cable Latch
Marshall ME980C-16-2F 2" 300# Flanged Latch		2" 300# Flanged	Cable Latch
Marshall ME980C-24-3F 3" 300# Flanged Cable		3" 300# Flanged	Cable Latch
Marshall ME980-24-4F 4" 300# Flanged Latch		3 300# Flanged	Cable Latch

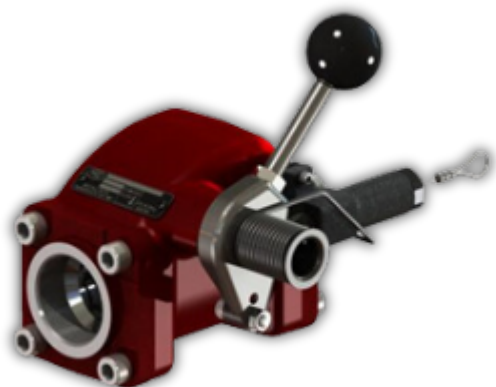

ME980C-6
Code: 180334

TRUCK & PLANT EQUIPMENT

F L O A T G A U G E S



E y o n a G a s E q u i p m e n t

w w w . e y o n a g a s . c o . z a

0 2 1 5 5 1 5 6 9 9 - 0 1 1 8 6 8 1 4 9 4



TANK FLOAT GAUGES

DESCRIPTION	CODE	TANK ID (MM)
ME930-63 Dial Size 4" (Glow in the dark)	1803101	1600mm
ME930WG-79 Dial Size 4" (Glow in the dark)	180310	2006,6mm
ME940-102 Dial Size 8" (glow in the dark)	1805041	2600mm
ME940-84 Dial Size 8" (glow in the dark)	180311	2133mm
ME940-95 Dial Size 8" (glow in the dark)	180400	2545mm
ME940-120 Dial Size 8" (glow in the dark)	180504	3048mm
ME940-123 Dial Size 8" (glow in the dark)	180843	3125mm



"Glow" Technology
Standard Dial



ME940 ASME Series / 8" Dial
Shown as Standard "Glow" Dial



ME930C DOT Series / 4" Dial
Shown as Classic Dial

TRUCK & PLANT EQUIPMENT

INTERNAL VALVES



E y o n a G a s E q u i p m e n t

w w w . e y o n a g a s . c o . z a

0 2 1 5 5 1 5 6 9 9 - 0 1 1 8 6 8 1 4 9 4



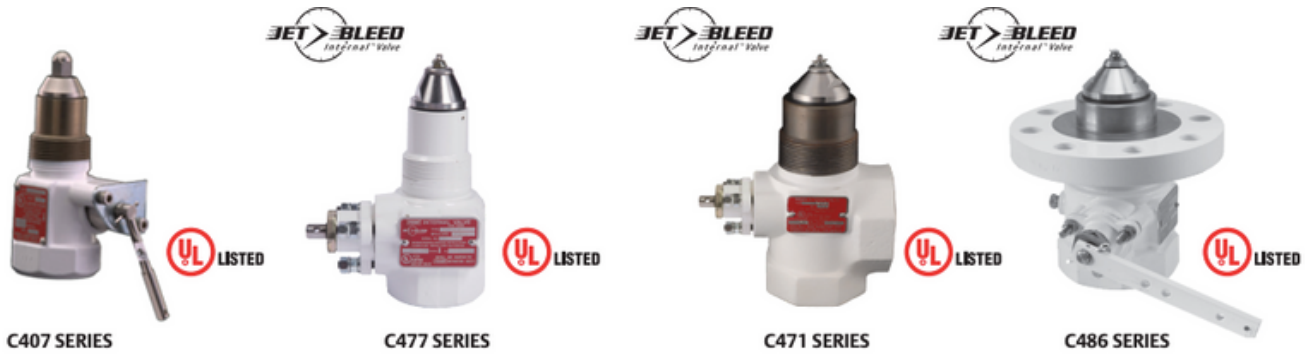

Description	Code	Closing Flow (L/Min)		Size
		Half Coupling	Full Coupling	
C407-10-04		152	95	1 ¼" MNPT x 1 ¼" FNPT
C407-10-05		189	133	1 ¼" MNPT x 1 ¼" FNPT
C407-10-08		303	246	1 ¼" MNPT x 1 ¼" FNPT
C477-16-10		397	227	2" MNPT x 2" FNPT
C477-16-15		568	303	2" MNPT x 2" FNPT

Description	Code	Closing Flow (L/Min)		Size
		Half Coupling	Full Coupling	
C477-16-15		568	303	2" MNPT x 2" FNPT
C477-16-25		946	492	2" MNPT x 2" FNPT
C477-24-16		606	454	3" MNPT x 3" FNPT
C477-24-26		1003	871	3" MNPT x 3" FNPT
C477-24-37		1419	1211	3" MNPT x 3" FNPT
C477-24-46		1741	1438	3" MNPT x 3" FNPT



C877 Series
Code:



C871 Series
Code:

Flanged Internal Valves

Description	Code	Closing Flow (L/Min)		Size
		Half Coupling	Full Coupling	
C486 - 24 - 16		606	454	3" CL300 RF x 3" FNPT
C486 - 24 - 26		1003	871	3" CL300 RF x 3" FNPT
C486 - 24 - 37		1419	1211	3" CL300 RF x 3" FNPT
C486 - 24 - 46		1741	1438	3" CL300 RF x 3" FNPT



C886 Series
Code:

Description	Code	Closing Flow (L/Min)		Size
		Half Coupling	Full Coupling	
C486 - 24 - 16		606	454	3" CL300 RF x 3" FNPT
C486 - 24 - 26		1003	871	3" CL300 RF x 3" FNPT
C486 - 24 - 37		1419	1211	3" CL300 RF x 3" FNPT
C486 - 24 - 46		1741	1438	3" CL300 RF x 3" FNPT

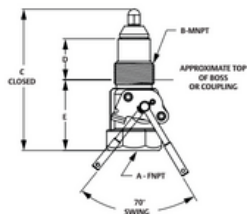

C407-10 AND C807-10 SERIES

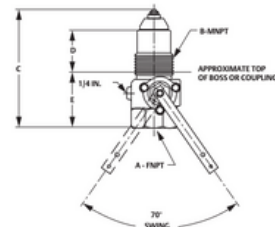

C477, C877 AND C897 SERIES

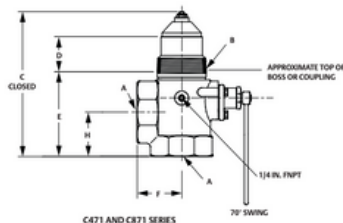

C471 AND C871 SERIES

TRUCK & PLANT EQUIPMENT

FLANGED INTERNAL VALVES



E y o n a G a s E q u i p m e n t

w w w . e y o n a g a s . c o . z a

0 2 1 5 5 1 5 6 9 9 - 0 1 1 8 6 8 1 4 9 4



Description	Code	Closing Flow (L/Min)		Size
		Bottom of Tank	Top of Tank	
SINGLE FLANGED		SINGLE FLANGED	SINGLE FLANGED	
C484 - 24 - 16		606	681	3"
C484 - 24 - 25		946	946	3"
C484 - 24 - 40		1514	1514	3"



TYPE C483-24

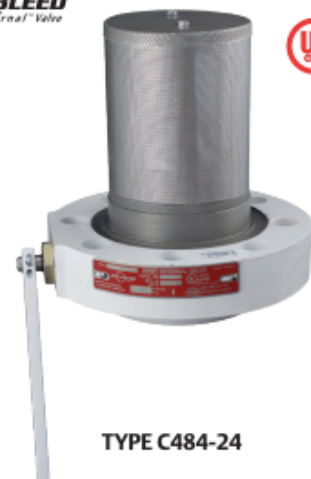

TYPE C484-24



Description	Code	Closing Flow (L/Min)		Size
		Bottom of Tank	Top of Tank	
DOUBLE FLANGED		DOUBLE FLANGED	DOUBLE FLANGED	
C483 - 24 - 16		606	681	3"
C483 - 24 - 25		1003	1098	3"
C483 - 24 - 40		1514	1514	3"

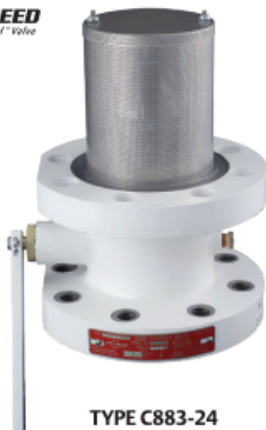

P Series Pneumatic Actuators All Fisher™ internal valves can be ordered with a pneumatic actuators that permits the valve to be opened and closed from a remote location. Two styles of pneumatic actuators are available: P600 Series 'Brake Chamber' style actuators and P700 Series 'Rotary' style rack-andpinion actuators. For the P600 Series when air pressure is applied to the actuator, it moves the actuator's rod and internal valve operating lever to the open position. Upon loss of air pressure, the valve's operating lever returns to the closed position. For the P700 Series, when air pressure is applied to the actuator, pistons act on a gear assembly that rotates the internal valve lever to the open position. Upon loss of air pressure, the valve will return to the closed position. Besides air pressure, nitrogen or carbon dioxide can also be used to pressure the actuators. In addition, the P700 Series supply source can be propane vapor.

Use of a pneumatic actuator permits the opening and closing of the internal valve to be tied into the air brake of the transport or bobtail. Pneumatic Actuators can also provide a convenient way to remotely operate a number of internal valves on stationary storage tanks at bulk plants.

Type P389 (1-1/4 in. / DN 32 Size) – This actuator can only be used with the C407-10 Series valve. All necessary hardware for installing the actuator is included. Minimum pressure is 60 psig / 4.1 bar; maximum pressure is 250 psig / 17.2 bar. Fuse Plug Part Number T1140399982 ordered separately.(1)

Types P613, P623, P639A and P614A Brake Chamber Actuators –

The actuator attaches directly to the valve after removal of the cableoperating lever. Included in each assembly is an operating lever and appropriate mounting hardware specific to each respective valve. These actuators can only be used with the internal valves as specified on the table below.

Types P731, P713, P714, P723 and P739 Rotary Actuators – The actuator attaches directly to the valve after removal of the cable-operating lever. Included in each assembly is an operating lever and appropriate mounting hardware specific to each respective valve in addition to air pressure, nitrogen and carbon dioxide, the P700 Series can be actuated with propane vapor.

Fuse Plugs – When installed in the actuator piping at the valve, will allow the pneumatic pressure to vent closing the valve if the plug is exposed to temperature between 208 to 220°F / 98 to 104°C. Fuse plugs are available in two sizes, 1/8 in. NPT (T1140399982) and 1/4 in. NPT (T1033699982). Fuse Plugs come with all Types P600 and P700 actuators, EXCEPT Type P389. Part Number T1140399982 to be ordered separately.(1)



NOTE: INTERNAL VALVES SHOWN ARE NOT INCLUDED.

TRUCK & PLANT EQUIPMENT

EMERGENCY SHUT OFF VALVES
FOR RAIL CARS



E y o n a G a s E q u i p m e n t

w w w . e y o n a g a s . c o . z a

0 2 1 5 5 1 5 6 9 9 - 0 1 1 8 6 8 1 4 9 4



EMERGENCY SHUT OFF VALVES FOR RAIL CARS

DESCRIPTION	CODE	SIZE	CLOSING FLOW LPM/LPG
Marshall ME983-16-150 2"FNPT 625LPM	180516	2" FNPT	625LPM
Marshall ME983-16-250 2"FNPT 1000LPM	180517	2" FNPT	1000LPM
Marshall ME983-16-500 2"FNPT 2000LPM	180518	2" FNPT	2000LPM



C886 Series
Code:

TRUCK & PLANT EQUIPMENT

G A U G E S



E y o n a G a s E q u i p m e n t

w w w . e y o n a g a s . c o . z a

0 2 1 5 5 1 5 6 9 9 - 0 1 1 8 6 8 1 4 9 4



Pressure Gauges

Description	Code
Gauge 100mm 0-1000kpa 1/2" Bottom Entry	1802041
Gauge 100mm 0-2500kpa 1/2" Bottom Entry	180205
Gauge 100mm 0-600kpa 1/2" Bottom Entry	180204
Gauge 63mm 0-10kpa 1/4" Bottom Entry	180193
Gauge 63mm 0-10kpa 1/8" Bottom Entry	180347
Gauge 63mm 0-2500kpa 1/4" Back Entry	180915
Gauge 63mm 0-2500kpa 1/2" Bottom Entry	180202

Pressure Gauges cont.

Description	Code
Gauge 63mm 0-250kpa 1/4" Bottom Entry	180192
Gauge 63mm 0-800kpa 1/4" Bottom Entry	160063
Gauge 63mm 0-250kpa 1/4" Bottom Entry	180192
Gauge 63mm 0-800kpa 1/4" Bottom Entry	160063
Gauge 63mm 0-800kpa 1/4" Bottom Entry	160063



Gauge 63mm 0-2500kpa
Code: 180202

TRUCK & PLANT EQUIPMENT

GAS METER
DIAPHRAGM/ROTARY/TURBINE



E y o n a G a s E q u i p m e n t

w w w . e y o n a g a s . c o . z a

0 2 1 5 5 1 5 6 9 9 - 0 1 1 8 6 8 1 4 9 4



About Metrix Italia

Metrix Italia is a company specialising in fiscal and industrial gas measurement, pressure control and regulation.

Their product range and technical expertise allow us to provide solutions for all needs: from domestic to industrial applications, through analog products and the so-called smart products of the latest generation.

The management of Metrix Italia has more than 40 years of technical and commercial expertise in the gas measurement and pressure regulation field.

We produce and offer the latest generation smart metering products updated to the latest transmission technologies (NBIOT) and ready to be used with the new green solutions (Hydrogen ready).

With a complete range of products, we are taking part in the transformation of the world of gas metering by supporting the implementation of smart gas metering. One of our goals is to support the utility companies and industries in the transition to new digital and smart measurement technologies for the creation of smart networks; this will be the way to grant reliable and efficient services to be ready for the ecological transition challenge of the future gas grids where multigas uses will allow the introduction of various green solutions. To complete our proposal we provide the data management of remote measurement, transmitted by smart devices installed in the field, through Meter Data Management software systems. We help to promote energy efficiency, reduce waste, and to promote higher sustainability in the use of gas

The logo for Metrix Italia, featuring the word "metrix" in a bold, blue, lowercase sans-serif font, followed by "italia" in a lighter blue, lowercase sans-serif font. A blue flame icon is positioned above the 'i' in "metrix".

Gas Meters

Types of meters

Diaphragm gas meters

The oldest meter is the volumetric diaphragm one which works by measuring the flow of gas through a mechanical volume measurement unit. This type of meter is based on a proven technology that has centuries-old origins; it's very accurate and reliable and has been used in the past for most domestic and commercial users.



Rotary gas meter

These gas meters are based on the principle of rotors, that is counter-rotating “eight-shaped” rotors, inside a cylindrical measuring chamber. They are volumetric meters with high precision and reliability in gas measurement. They shall be combined with modern electronic volume converters for pressure and temperature correction, to ensure the accuracy of data measurement.



Turbine gas meters

Turbine gas meters are generally very accurate and reliable, used in the first and secondary distribution of natural gas. They can be incorporated into pressure regulation units or cabinets and in different industrial applications for gas measurement. They shall be combined with modern electronic volume converters for pressure and temperature correction to ensure the accuracy of data measurement.



Quantometers

They are typically turbine meters for commercial and industrial applications for internal, divisional, departmental gas measurements – however not for legal metrology applications. They are generally cheaper than turbine meters for fiscal use. They can also be combined with modern electronic volume converters for pressure and temperature correction.



We could not include all the meters available , below are some of the most commonly sold in Southern Africa. Please get in touch us with for more options.

GAS METER DIAPHRAGM

DESCRIPTION	CODE	MAX CAPACITY (KG/H)	MAX INLET PRESSURE (KPA) 100KPA=1BAR	THREAD SIZE
G2.5 D Vapour	180185	8kg/h	50Kpa	1 ¼" x 1 ¼"
G4 D Vapour	160065	12kg/h	200Kpa	1 ¼" x 1 ¼"
G10 D Vapour	180610	32kg/h	50Kpa	1 ¼" x 1 ¼" OR 2" x 2"
G16 D Vapour	160070	50kg/h	50Kpa	2" x 2"
G40 D Vapour	1600701	130kg/h	50Kpa	2 ½" x 2 ½" OR 3" x 3"



G2,5 8kg/hr
Code: 180815



G6 20kg/hr
Code: 180815

GAS METER ROTARY CUSTODY TRANSFER

DESCRIPTION	CODE	MAX CAPACITY (KG/H)	MAX INLET PRESSURE (KPA) 100KPA=1BAR	THREAD SIZE
G16 Rotary Meter		50kg/hr	2000kpa	1 1/2" x 1 1/2" OR 2" x 2"
G40 Rotary Meter	180301	130Kg/hr	2000Kpa	1 1/2" x 1 1/2" OR 2" x 2"
G65 Rotary Meter		200Kg/hr	2000Kpa	2" x 2"
G100 Rotary Meter		320Kg/hr	2000Kpa	3" x 3" OR 4" x 4"



CGR Rotary 130kg/hr
Code: 180301

GAS METER TURBINE CGT-02 CUSTODY TRANSFER

DESCRIPTION	CODE	MAX CAPACITY (KG/H)	MAX INLET PRESSURE (KPA) 100KPA=1BAR	THREAD SIZE DN
G65 CGT-02		200kg/hr		DN50
G100 CGT-02		320kg/hr		DN80
G250 CGT-02		800kg/hr		DN80/DN100
G1000 CGT-02		3200kg/hr		DN150
G1600 CGT-02		5100kg/hr		DN200



G100 CGT-02 430kg/hrr

Code:

GAS METER TURBINE CPT-01 NON-FISCAL

DESCRIPTION	CODE	MAX CAPACITY (KG/H)	MAX INLET PRESSURE (KPA) 100KPA=1BAR	THREAD SIZE
G25 CPT-01		80kg/hr		1"
G40 CPT-01	180667	130Kg/h		2"
G100 CPT-01	180176	320kg/h		2 1/2"
G250 CPT-01	1802003	800Kg/h		4"
G650 CPT-01	1802001	2050Kg/h		6"



G25 CPT-01 80kg/hr
Code:

TRUCK & PLANT EQUIPMENT

MANIFOLDS

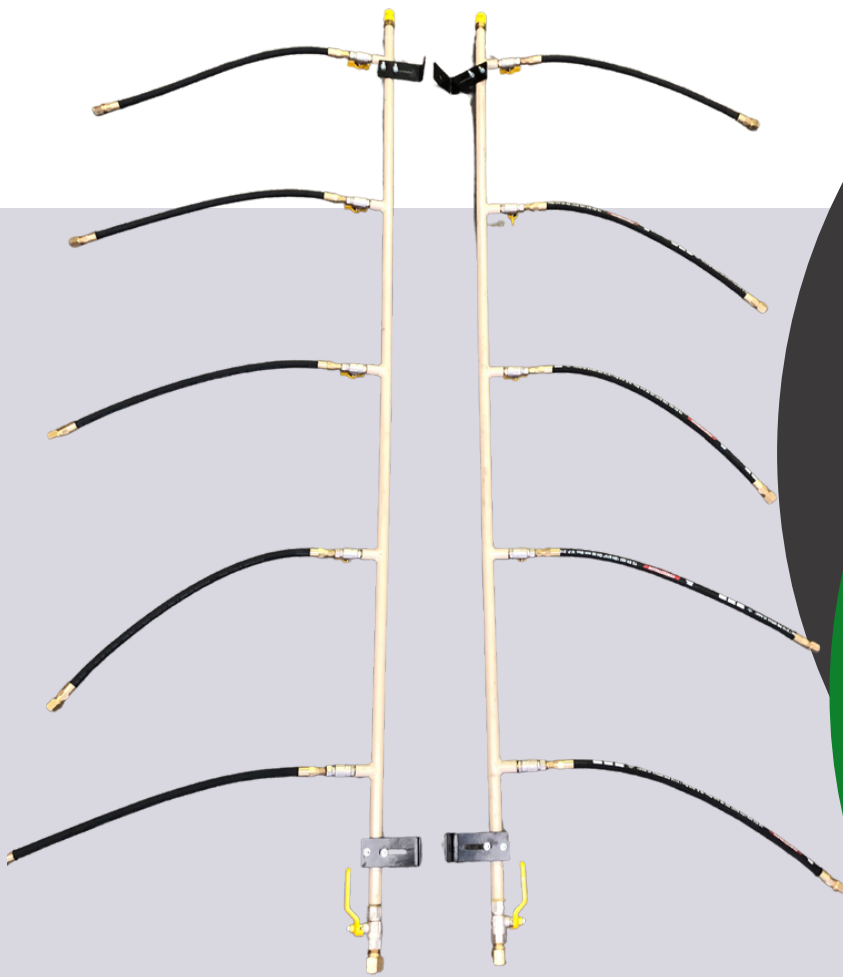

E y o n a G a s E q u i p m e n t

w w w . e y o n a g a s . c o . z a

0 2 1 5 5 1 5 6 9 9 - 0 1 1 8 6 8 1 4 9 4



LIQUID MANIFOLD COMPLETE

DESCRIPTION	CODE
Manifold Double 2 Liquid complete w/pigtails	180918
Manifold Double 3 Liquid complete w/pigtails	1802102
Manifold Double 4 Liquid complete w/pigtails	1802103
Manifold Double 5 Liquid complete w/pigtails	180210
Manifold Double 6 Liquid complete w/pigtails	1802101
Manifold Double 8 Liquid complete w/pigtails	
Manifold Double 10 Liquid complete w/pigtails	1802110

LIQUID MANIFOLD COMPACT

DESCRIPTION	CODE
Manifold Double 2 Liquid complete w/pigtails compact	
Manifold Double 3 Liquid complete w/pigtails compact	
Manifold Double 4 Liquid complete w/pigtails compact	
Manifold Double 5 Liquid complete w/pigtails compact	180957
Manifold Double 6 Liquid complete w/pigtails compact	
Manifold Double 8 Liquid complete w/pigtails compact	
Manifold Double 10 Liquid complete w/pigtails compact	180837

VAPOUR MANIFOLD COMPLETE

DESCRIPTION	CODE
Manifold Double 2 Vapour complete w/pigtails	180139
Manifold Double 3 Vapour complete w/pigtails	180140
Manifold Double 4 Vapour complete w/pigtails	180159
Manifold Double 5 Vapour complete w/pigtails	180160
Manifold Double 6 Vapour complete w/pigtails	180364
Manifold Double 8 vapour complete w/pigtails	1801701
Manifold Double 10 Vapour complete w/pigtails	180170

VAPOUR MANIFOLD COMPACT

DESCRIPTION	CODE
Manifold Double 2 Vapour complete w/pigtails compact	
Manifold Double 3 Vapour complete w/pigtails compact	
Manifold Double 4 Vapour complete w/pigtails compact	180148
Manifold Double 5 Vapour complete w/pigtails compact	180372
Manifold Double 6 Vapour complete w/pigtails compact	180443
Manifold Double 8 Vapour complete w/pigtails compact	180353
Manifold Double 10 Vapour complete w/pigtails compact	180183

STAINLESS STEEL MANIFOLDS

LIQUID NORMAL

DESCRIPTION	CODE
Manifold SS Double 2 Liquid complete w/pigtails	
Manifold SS Double 3 Liquid complete w/pigtails	
Manifold SS Double 4 Liquid complete w/pigtails	
Manifold SS Double 5 Liquid complete w/pigtails	
Manifold SS Double 6 Liquid complete w/pigtails	
Manifold SS Double 8 Liquid complete w/pigtails	
Manifold SS Double 10 Liquid complete w/pigtails	

STAINLESS STEEL MANIFOLDS

LIQUID COMPACT

DESCRIPTION	CODE
Manifold SS Double 2 Liquid complete w/pigtails compact	
Manifold SS Double 3 Liquid complete w/pigtails compact	
Manifold SS Double 4 Liquid complete w/pigtails compact	
Manifold SS Double 5 Liquid complete w/pigtails compact	
Manifold SS Double 6 Liquid complete w/pigtails compact	
Manifold SS Double 8 Liquid complete w/pigtails compact	
Manifold SS Double 10 Liquid complete w/pigtails compact	

